



Marvair[®]
AIRXCEL[™], Inc.

ISO 9001:2008 REGISTERED COMPANY

Classic Heat Pumps

Vertical Packaged Heat Pumps

Single stage cooling models AVPA24-30-36-42-48-60 and
HVPA24-30-36-42-49-60 and
2-stage cooling models HVPSA36-42-49-60

General Description

The Marvair[®] Classic wall mounted heat pumps are the ideal HVAC system for a wide variety of applications. The exterior mounting means that no valuable interior space is required. The Classic heat pumps are packaged units – the refrigerant piping and internal wiring are factory assembled and thoroughly tested. All components are readily accessible for easy service and maintenance. The energy efficient operation keeps operating costs to a minimum and makes the Marvair heat pumps ideal problem solvers for a wide variety of applications, including offices, classrooms and telecommunication shelters.

Three Series to meet any Budget or Efficiency Requirement - Three series of Classic heat pumps are available. The Classic HVPA models are our most efficient models and feature EERs (Energy Efficiency Ratio) of up to 11.50. No wall mount heat pump is more efficient. The HVPSA models feature a 2-stage compressor that matches the cooling capacity to the heat load. Our AVPA models have EERs of up to 9.75. The AVPA & HVPA (single stage compressor units) are built in nominal cooling capacities of 2, 2½, 3, 3½, 4 and 5 tons. The HVPSA (2-stage compressor) units are available in nominal cooling capacities of 3, 3½, 4 and 5 tons.

Outside Air for Ventilation or Free Cooling - A full range of accessories and options allows the Classic heat pumps to be optimized for each application. For classrooms, a complete range of ventilation options are available to meet the fresh air requirements of the ASHRAE 62 standard, "Ventilation for Acceptable Indoor Air Quality", including the exclusive Marvair GreenWheel[®] Energy Recovery Ventilator. Where cooling is required during cool or cold weather, e.g., telecommunications shelters, a factory installed economizer should be used. To insure proper operation and optimum performance, all outside air ventilation packages are non-removable, factory installed and factory calibrated.

2-Stage Compressor -The HVPSA models feature a two stage compressor with a first stage capacity of 65% of the total capacity. The two stage compressor offers better comfort by maintaining more precise temperature and relative humidity levels with improved overall energy efficiency. During mild days, the first stage can satisfy the load, minimizing temperature fluctuations providing steady, even comfort. With Integrated Part Load Performance Values (IPLV) of up to 15.0, the Classic heat pump with the two stage, high efficiency compressor can provide significant energy savings compared to older, less efficient systems. The cooling mode has two stage operation; heating is single stage.

Quiet in the Classroom - In addition to high efficiency, the HVPA and HVPSA models minimize sound levels in the classroom. A high efficiency axial fan moves air silently through the outdoor coils. A low vibration, scroll compressor insures quiet operation as well as energy efficiency. The indoor air mover utilizes a revolutionary electronically commutated motor (ECM). This motor consumes a minimum of power with whisper quiet operation. The ECM automatically adjusts its speed to maintain the proper air flow at various external static pressures.



Safety Listed and Energy Certified - All Classic heat pumps are built to UL standard 1995, 4th edition and CAN/CSA C22.2, No. 236-11, 2nd edition. For energy efficiency and performance, the units are tested and rated in accordance to the ANSI/AHRI (Air-Conditioning Heating and Refrigeration Institute) Standard 390 (Single Package Vertical Units). All units meet or exceed the efficiency requirements of ANSI/ASHRAE/IESNA 90.1.2007. The Classic heat pumps are commercial units and are not intended for use in residential applications.

Dehumidification - The introduction of outside air can cause humidity levels to rise to unacceptable levels. To reduce humidity, the Classic heat pumps can be ordered with a Hot Gas Reheat (HGR) coil. The HGR coil allows the heat pump to dehumidify without adversely lowering the temperature in the classroom and uses less energy than electric reheat. When used in conjunction with the GreenWheel[®] ERV, humidity levels can be controlled at a minimum of expense. See page 4 for a detailed description of the operation of the Hot Gas Reheat Coil.



Classic™ Heat Pump Features

High Efficiency

- Scroll compressors are standard on all units.
- Lanced fins and rifled tubing on the indoor & outdoor coils maximize heat transfer.
- Electronically commutated indoor blower motor on the HVPA & HVPSA models and two speed indoor blower motor on the AVPA models.

Engineered Reliability

- PC board simplifies wiring, consolidates several of the electrical functions in one device.
- High refrigerant pressure switch with lockout relay protects the compressor in the event of insufficient condenser air flow.
- Loss of charge pressure switch with lockout relay protects the compressor in the event of a

- loss of refrigerant or inadequate evaporator air flow.
- Time delay for short cycle protection.

Ease of Installation

- Sloped top with flashing eliminates need of rain hood.
- Built-in mounting flanges facilitate installation and minimize chance of water leaks.
- Factory installed disconnect on all units, including 460v. models.
- Outside air hood included with each unit.
- Single Point Power Entry complies with latest edition of U.L. Standard 1995.

Rugged Construction

- Baked on beige finish over galvaneel steel on exterior sheet metal.

- Copper tube, aluminum fin evaporator and condenser coils.
- Corrosion resistant Dacromet® external fasteners.

Ease of Service

- LED's on the control board indicate operational status and fault conditions.
- Refrigerant access valves are standard
- All major components are readily accessible
- Front control panel allows easy access and complies with NEC clearance codes on side by side units.
- Major components accessible from either side.

Outside Air for Ventilation

ASHRAE standard 62 requires 30 cfm of outside air per occupant of a classroom. To meet this requirement, Marvair offers five ventilation packages for every budget and requirement.

- GreenWheel® total Energy Recovery Ventilator that can recover both sensible and latent heat with efficiencies up to 65%. Ventilation Configuration "H".
- Manual, two position damper (open and closed) capable of 0 to 450 cfm of outside air; includes pressure relief. A 24-volt actuated motor controls the damper from an external input such as a time clock, CO₂ sensor, energy management system or a manual switch. Ventilation Configuration "B".
- Manual damper capable of 0 to 450 cfm of outside air (not to exceed 40% of rated air flow), field adjustable, includes pressure relief. Ventilation Configuration "Z".
- Manual damper capable of 0 to 450 cfm of outside air (not to exceed 40% of rated air flow), field adjustable, no pressure relief. Ventilation Configuration "Y".
- Manual damper capable of up to 15% of rated airflow of outside air; field adjustable, no pressure relief. Ventilation Configuration "N".
- GreenCube® total Energy Recovery Ventilator that can recover both sensible and latent heat. Includes two ventilation motors- one for intake air and a second for the exhaust air and two controllers to allow independent control of each motor. Ventilation Configuration "Q".

Outside Air Ventilation Schedule

Ventilation Package Designator*	Description	Outside Air Capability	Pressure Relief
H	GreenWheel® ERV. Includes a ventilation intake air blower, a ventilation intake air filter, a ventilation exhaust blower and a single fan speed controller for both motors. Optional second fan speed controller for the exhaust air. This second controller allows independent control of the exhaust air motor and positive pressurization of the classroom.	0-450 CFM	Yes
B	Motorized, two position damper (open and closed) includes pressure relief. A 24-volt actuated motor controls the damper from an external input such as a time clock, CO ₂ sensor, energy management system or a manual switch.	Up to 450 cfm, but not to exceed 40% of the rated air flow of the heat pump.	Yes
Z	Manual damper, field adjustable	Up to 450 cfm, but not to exceed 40% of the rated air flow of the heat pump.	Yes
Y	Manual damper, field adjustable	Up to 450 cfm, but not to exceed 40% of the rated air flow of the heat pump.	No
N	Manual, fixed position damper	0-15% of rated air flow	No
C	Economizer	100% of rated air flow of outside air	Yes
Q	GreenCube® ERV	0-300 cfm of outside air	Yes

*See Model Identification Chart.

Classic Heat Pump Ventilation Option

GreenWheel® ERV exhaust air motor controller – Allows independent control of the exhaust and intake blowers. When used, the standard speed controller operates the intake blower and the optional second controller, the exhaust blower. Individual blower control allows positive pressurization of the classroom. Field or factory installed.

The Unique Marvair® GreenWheel® Energy Recovery Ventilator

The Marvair® GreenWheel® ERV is a total energy (both sensible and latent) wheel that reduces both construction and operating cost while ventilating the classroom to ASHRAE 62-1999 requirements. The use of the GreenWheel ERV reduces the energy load of the outside air. Exhausting stale, inside air keeps indoor pollutants and harmful gases to a minimum. The Marvair GreenWheel ERV has been tested and certified according to ARI Standard 1060.

How It Works - During the summer, cool dry air from the classroom is exhausted through the GreenWheel ERV to the outside. As the air passes through the rotating wheel, the desiccant becomes cooler and drier. Simultaneously, hot humid air is being pulled across the rotating wheel. The cool, dry desiccant absorbs moisture and heat from the incoming air. The cooler, drier air is mixed with the return air from the classroom and distributed throughout the room.

In the winter, warm moist air is exhausted through the GreenWheel ERV to the outside. As the air passes through the rotating wheel, the desiccant becomes warmer and absorbs moisture. Simultaneously, cold dry air is being pulled across the rotating wheel. The cold, dry air absorbs heat and moisture from the desiccant. The warmed air is mixed with the return air from the classroom and distributed throughout the room.

Quality Components - The GreenWheel ERV Ventilation package consists of the GreenWheel cassette, an incoming air blower, an exhaust air blower, an air filter for the incoming air and one fan speed controller that controls the speed of both blower motors simultaneously. As an option, a second fan speed controller can be factory installed for independent control of the exhaust air motor and positive pressurization of the classroom. Also, an optional filter on the exhaust air is available on selected models. Please consult your Marvair representative for details. The two blowers simultaneously pull fresh air from outside and exhaust air from the classroom through the rotating wheel. The air streams are separated by an insulated partition so that the incoming fresh air is not mixed with the exhaust air. Two variable speed blowers ensure that up to 450 CFM of outside air can be brought into the room and the indoor air is properly exhausted. Variable speed blowers permit that the desired quantity of outside air is delivered into the room. Optional independent exhaust air blower control allows positive pressurization of the classroom, i.e., more outside air can be introduced through the GreenWheel ERV than is exhausted.

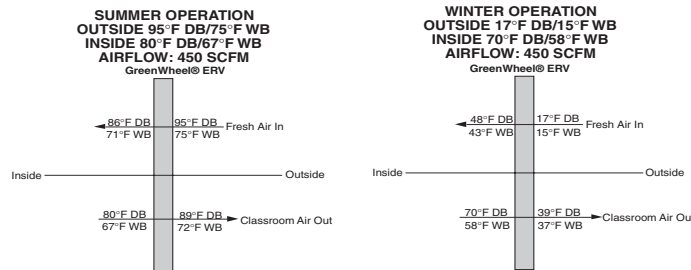

GreenWheel® ERV Performance

SCFM* of Outside Air	95° DB/73° WB Outside 80° DB/67° WB Inside			95° DB/80° WB Outside 80° DB/67° WB Inside		
	Energy Conserved, BTUH					
	Sensible	Latent	Total	Sensible	Latent	Total
225	2,900	1,100	4,000	2,900	6,400	9,300
250	3,100	1,200	4,300	3,100	6,900	10,000
325	3,700	1,400	5,100	3,700	8,100	11,800
400	4,200	1,500	5,700	4,200	9,100	13,300
450	4,500	1,600	6,100	4,500	9,700	14,200

SCFM* of Outside Air	90° DB/74° WB Outside 75° DB/64° WB Inside			80° DB/70° WB Outside 75° DB/64° WB Inside			60° DB/54° WB Outside 70° DB/58° WB Inside		
	Energy Conserved, BTUH								
	Sensible	Latent	Total	Sensible	Latent	Total	Sensible	Latent	Total
225	2800	3600	6400	900	2800	2700	1900	200	2100
250	3000	3800	6800	1000	3000	4000	2000	200	2200
325	3600	4500	8100	1200	3500	4700	2400	200	2600
400	4100	4900	9000	1400	3800	5200	2700	300	3000
450	4300	5200	9500	1400	4000	5400	2900	300	3200

SCFM* of Outside Air	40° DB/36° WB Outside 70° DB/58° WB Inside			20° DB/18° WB Outside 70° DB/58° WB Inside			0° DB/7° WB Outside 70° DB/58° WB Inside		
	Energy Conserved, BTUH								
	Sensible	Latent	Total	Sensible	Latent	Total	Sensible	Latent	Total
225	5600	3300	8900	9300	4900	14200	13000	5700	18700
250	6000	3600	9600	10000	5300	15300	14000	6100	14100
325	7200	4200	11400	12000	6200	18200	16700	7100	23800
400	8100	4600	12700	13500	6800	20300	18900	7900	26800
450	8600	4800	13400	14400	7100	21500	20100	8200	28300

*SCFM = Standard Cubic Feet per Minute

For performance of the GreenWheel ERV at conditions other than those shown, please contact your Marvair® representative or the factory. A return filter grille is required on all HVP24 heat pumps with the GreenWheel ERV ventilation option.

Economizer

The economizer reduces the cost of air conditioning by using outside air when acceptable to cool the room. The factory installed Marvair® economizer has integral pressure relief. On a signal from a thermostat that cooling is required, either mechanical cooling with the compressor or free cooling with the economizer is provided. The Marvair economizer is capable of bringing in outside air equal to 100% of the rated cooling capacity of the unit and has built in pressure relief.

An internal enthalpy controller determines whether the outside air is sufficiently cool and dry to be used with cooling. If suitable, the compressor is locked out and the economizer damper opens to bring in outside air. The temperature at which the economizer opens is adjustable from approximately 55°F (13°C) to 73°F (23°C) at 50% RH. If the outside air becomes too hot or humid, the economizer damper closes completely or to a minimum position and mechanical cooling is activated. When used with minimum position potentiometer (optional), the Marvair® economizer can meet requirements of ASHRAE Std. 62.

GreenCube® ERV Ventilation Configuration “Q”

The Marvair GreenCube® ERV is an enthalpy plate heat exchanger that transfers both sensible and latent energies between outgoing and incoming air streams in a cross flow arrangement. Except for two air movers, it has no moving parts. It can introduce up to a maximum of 300 cfm of outside air into the classroom. Two MERV 6 type filters are used on both sides of the enthalpy core. The fresh air and exhaust motors have independent speed controllers to permit each of the motors to be regulated independently.

The media is impregnated with a RC134 polymeric desiccant that exchanges water by direct vapor transfer using molecular transport without the need of condensation. The GreenCube® ERV will operate at temperatures as low as 10°F with no defrost mechanism. In addition, the desiccant is a bactericide.

The GreenCube® ERV is only available on HVPSA units (2-stage compressor). **All HVPSA units with the GreenCube® ERV, including the HVPSA36 and HVPSA42, are in the HVPSA49/60 cabinet (see page 28).**

Hot Gas Reheat Operation

Marvair® heat pumps equipped with Hot Gas Reheat (HGR) allow the indoor humidity of the controlled environment to be maintained at or below a certain humidity set point. These units do not have the ability to add humidity to the classroom. Dehumidification is achieved by operating mechanical cooling in conjunction with a hot gas reheat coil.

Operation - If the humidity rises above the set point on the humidity controller and the temperature in the classroom is satisfied, both mechanical cooling and the HGR coil operate to temper the air and lower the humidity. If the temperature in the classroom rises above (or falls below) the set point of the thermostat and the unit is operating in the dehumidification mode, the call for cooling (or heating) will override the call for dehumidification and the coil is disengaged until the thermostat is satisfied. This assures the environment temperature is maintained as first priority and humidity control is second.

Heat Pump PC Board

Each Classic heat pump has a PC board that controls the operation of the indoor blower, the compressor and the reversing valve while providing high refrigerant pressure and loss of refrigerant protection with an integral defrost function. In addition, the board has user selectable pins and potentiometers for multi-function control.

High & loss of refrigerant protection – If either of these fault conditions occur twice within an one hour, the control board will enter into and indicate the lockout mode. In the lockout mode, the compressor will not operate, the alarm output is energized and the red LED will blink to indicate which fault has occurred. The user can select either Normally Open or Normally Closed contacts.

Compressor anti-short cycle protection – An integral three minute delay prevents compressor from destructive short cycling.

Loss of Refrigerant By-pass Timer – To prevent nuisance fault alarms, the board ignores a loss of charge fault for three minutes on start-up of the compressor.

Defrost Control – The defrost cycle removes ice build-up on the outdoor coil during the heating cycle. If the defrost sensor senses a coil temperature of 32°F while in the heat mode, a 30, 60 or 90 minute (user selectable) delay period will begin. After the delay period if the sensor is still calling for a defrost cycle, the outdoor fan will be stopped and the reversing valve energized. The defrost cycle will stop if the defrost sensor registers a temperature of 50°F or after 10 minutes.

By moving a pin on the board, the user can have electric heat operating during the defrost cycle or not operate.

S-Circuit – The user can move a pin on the board to control whether the electric heat will operate simultaneously with the compressor.

Indoor Blower Speed Control – a speed control potentiometer mounted on the board allows the user to vary the blower speed on the AVPA heat pumps from 40% to 100% of rated air flow. (Not applicable to the HVPA and HVPSA units with the electronically commutated indoor blower motor).

Ventilation Damper Relay – The board has a dedicated relay to control a two position – Open & Closed - motorized fresh air damper (Ventilation Configuration "B").

Protection of the Refrigerant Components

High Refrigerant Pressure Switch – The high pressure switch is located on the liquid line. It is electrically connected to the PC board and will turn the compressor off if the pressure rises above the set point twice within one hour. This protects the compressor if airflow is significantly reduced or lost through the coil performing the condenser function.

Loss of Charge Switch – The loss of charge switch is located on the liquid line. It is electrically connected to the PC board and will turn the compressor off if the pressure drops above the set point twice within one hour. This protects the compressor if airflow is significantly reduced or lost through the coil performing the evaporator function or there is a loss of refrigerant.

Classic Heat Pump Options

Marvair® options can be used to provide optimum performance over a full range of operating conditions.

Adjustable Outdoor Thermostat – Will not allow electric resistance heat to be energized unless the outdoor temperature is below the desired set point. Field or factory installed. Available on all Classic™ units.

Energy Management System (EMS) Relay Kit -Relay to control the unit. Available in 24, 120 or 240 VAC. Field or factory installed.

Electric Reheat – Control provides simultaneous operation of compressor when in cooling mode and the electric elements to provide dehumidification without over cooling the room. The electric element (kW) must be properly sized for each model for proper operation. Factory installed. Available on all Classic™ units. Consult factory for details.

Phase Monitor - Monitors 3Ø power supply and will turn the air conditioner off if power supply is not phased properly. Not required on 1Ø units.

Compressor sound jackets - Reduces sound of compressor

Special Application Packages and Coil Coatings

Coastal Environmental Package - Recommended for units to be installed near an ocean or on seacoast. Includes corrosion resistant fasteners, sealed or partially sealed condenser fan motor, protective coating applied to all exposed internal copper and metal in the condenser section and a protective coating on the condenser coil. See Coastal Environmental Technical Bulletin for more details.

Protective Coil Coatings - Either the condenser or evaporator coil can be coated, However, coating of the evaporator coil is not common. For harsh conditions, e.g., power plants, paper mills or sites where the unit will be exposed to salt water; the coil should be coated. Note: Cooling capacity may be reduced by up to 5% on units with coated coils.

With built-in temperature and humidity sensors, motion sensing and an optional CO2 detection sensor, the MAR7000 can control:

- Single or 2-stage air conditioners or heat pumps with supplemental hot water or electric heat,
- Hot gas dehumidification operation,
- An economizer cycle, and
- Marvair’s various ventilation options including the Marvair GreenWheel® Energy Recovery Ventilator.

The intelligent occupancy anticipation feature of the MAR7000 automatically programs occupied and unoccupied settings for temperature, humidity, and ventilation requirements. The ventilation control can be based on occupancy, demand, time, or a combination of these features. When vacant, the thermostat automatically reduces the run time of the unit and adjusts ventilation to save energy. The intelligent occupancy feature can be turned off, and the MAR7000 can be connected to a BACnet control system for remote control and operation of Marvair heat pumps or air conditioners. The MAR7000 thermostat includes a precise, real time clock with capacitor back up to maintain the program and set points for extended power outages.

Features include:

- User-friendly English-language menus (no obscure numeric codes) on a 64 x128 pixel, dot-matrix LCD display with 5 buttons for data selection and entry,
- Built-in, factory-tested libraries of configurable application control sequences,
- Schedules that can easily be set uniquely by weekdays (Mon.–Fri.), weekend (Sat.–Sun.), entire week (Mon.–Sun.), individual days, and/or holidays,
- Six On/Off and independent heating and cooling set point periods are available per day, and
- Three levels of password-protected access (user/operator/administrator) prevent disruption of operation and configuration

Thermostat guards

Clear thermostat guard with keylock & clear plastic cover & base. For use with 50121, 50123, 50186, 50107 and 50252 thermostats. *Marvair P/N 50092.*

Clear thermostat guard with keylock & clear plastic cover & base. For use with 50248 thermostat. *Marvair P/N50119.*

Humidity controller

Digital humidity controller. To be used with units with Hot Gas or electric reheat. Programmable dehumidistat, ventilation control. Permanent memory retention of set points. Humidity sensor can be field calibrated. High & low dehumidification set points. Outdoor temperature and humidity sensor included. °F or °C selectable. *Marvair P/N 50254.*

Grilles

Description	Size	Marvair P/N
<i>For the AVPA24</i>		
Double deflection, aluminum supply grille	20" x 8" (509mm x 203mm)	80674
Aluminum return grille	20" x 12" (509mm x 305mm)	80677
Return filter grille	20" x 12" (509mm x 305mm)	80671
<i>For the AVPA30/36 & HVPA24*</i>		
Double deflection, aluminum supply grille	28" x 8" (711mm x 203mm)	80675
Aluminum return grille	28" x 14" (711mm x 356mm)	80678
Return filter grille*	28" x 14" (711mm x 356mm)	80672
<i>*A return air filter grille is required on all AVPA24/30/36 & HVPA24 when GreenWheel® ERV is used.</i>		
<i>For the AVPA42, 48, 60, & 72; HVPA30, 36, 42, 49 & 60 and HVPSA 36, 42, 49 & 60</i>		
Double deflection, aluminum supply grille	30" x 10" (762mm x 254mm)	80676
Aluminum return grille	30" x 16" (762mm x 406mm)	80679
Return filter grille	30" x 16" (762mm x 406mm)	80673
Note: Return filter grilles should be used when the 2" (51mm) filter in the Classic unit is not accessible from the exterior of the building. Filter used in the return filter grille is a 1" (25mm) thick filter. The return filter grille is not recommended for use with the Classic II heat pumps with economizers.		

Certified Efficiency and Capacity Ratings at ANSI/ARI Standard 390 - AVPA Heat Pumps

Model Number	AVPA24			AVPA30			AVPA36			AVPA42			AVPA48			AVPA60		
	HPA	HPC	HPD	HPA	HPC	HPD	HPA	HPC	HPD	HPA	HPC	HPD	HPA	HPC	HPD	HPA	HPC	HPD
Cooling BTUH¹	24,000			29,000			35,000			42,000			46,000			54,000		
EER²	9.30			9.40			9.30			9.20			9.50			9.00		
High Temperature Heating³	24,000			30,000			35,000			34,000			42,000			53,000		
High Temperature COP⁴	3.00			3.00			3.00			3.00			3.00			3.00		
Rated Air Flow (CFM⁵)	820			1,000			1,200			1,350			1,600			1,600		

¹Cooling is rated at 95°F (35°C) outdoor and 80°F DB/67°F WB (26.5°C DB/19.5°C WB) return air.

²EER = Energy Efficiency Ratio

³High Temperature Heating & COP are rated at 47°F DB/43°WB (8.3°C DB/6.1°C WB) outdoor and 70°F (21.1°C) return air.

⁴COP = Coefficient of Performance

⁵CFM = Cubic Feet per Minute

Ratings are with no outside air. Performance will be affected by altitude. Ratings are at 230 volts for 208/230 volt units ("A" & "C" models) and 460 volts for "D" models. Operation of units at a different voltage from that of the rating point will affect performance and air flow.

Sensible Total Heat Ratio @ 95°F (35°C) Outside Air DB - AVPA Heat Pumps

Model Number	AVPA24			AVPA30			AVPA36			AVPA42			AVPA48			AVPA60		
	HPA	HPC	HPD	HPA	HPC	HPD	HPA	HPC	HPD	HPA	HPC	HPD	HPA	HPC	HPD	HPA	HPC	HPD
Total Capacity	24,000			29,000			35,000			42,000			46,000			54,000		
Sensible Heat Ratio	0.78			0.74			0.70			0.70			0.72			0.67		
Sensible Capacity	18,770			21,385			24,560			29,545			33,060			36,260		
Rated Air Flow (CFM¹)	820			1,000			1,200			1,350			1,600			1,600		

¹CFM=Cubic Feet per Minute

Sensible Heat Ratios based upon ANSI/AHRI std. 390 outdoor conditions of 95°F (35°C) outdoor and 80°F DB/67°F WB (26.5°C DB/19.5°C WB) return air.

Cooling Performance (BTUH) at Various Outdoor Temperatures - AVPA Heat Pumps

Model Number	Outdoor Temperature									
	75°F/24°C	80°F/26.5°C	85°F/29°C	90°F/32°C	95°F/35°C	100°F/38°C	105°F/40.5°C	110°F/43.3°C	115°F/46°C	
AVPA24HP	27,840	26,880	25,920	24,960	24,000	23,040	22,080	21,120	20,640	
AVPA30HP	33,640	32,480	31,320	30,160	29,000	27,840	26,680	25,520	24,940	
AVPA36HP	40,600	39,200	37,800	36,400	35,000	33,600	32,200	30,800	30,100	
AVPA42HP	48,720	47,040	45,360	43,680	42,000	40,320	38,640	36,960	36,120	
AVPA48HP	53,360	51,520	49,680	47,840	46,000	44,160	42,320	40,480	39,560	
AVPA60HP	62,640	60,480	58,320	56,160	54,000	51,840	49,680	47,520	46,440	

Based upon ANSI/AHRI std. 390 return air conditions of 80°F DB/67°F WB (26.5°C DB/19.5°C WB). Return air at rated air flow.

Heating Performance (BTUH) at Various Outdoor Temperatures - AVPA Heat Pumps

Model Number	Outdoor Temperature									
	10°F / -12.2°C	17°F / -8.3°C	20°F / -6.7°C	30°F / -1.1°C	40°F / 4.4°C	47°F / 8.3°C	50°F / 10°C	60°F / 15.6°C	70°F / 21.1°C	
AVPA24HP	11,560	13,600	14,640	18,280	21,400	24,000	24,720	25,800	27,000	
AVPA30HP	15,130	17,800	19,020	23,290	26,950	30,000	30,900	32,250	33,750	
AVPA36HP	15,810	18,600	20,240	25,980	30,900	35,000	36,050	37,625	39,375	
AVPA42HP	18,700	22,000	23,200	27,400	31,000	34,000	35,020	36,550	38,250	
AVPA48HP	20,400	24,000	25,800	32,100	37,500	42,000	43,260	45,150	47,250	
AVPA60HP	28,050	33,000	35,000	42,000	48,000	53,000	54,590	56,975	59,625	

Based upon ANSI/AHRI std. 390 return air conditions of 70°F DB (21.1°C DB). Return air at rated air flow.

Air Flow (Cubic Feet per Minute)

Model Number	External Static Pressure (WET COIL)					
	0.10	0.20	0.25	0.30	0.40	0.50
AVPA24	860	810	740	670		
AVPA30	1100	1000	960	920	810	
AVPA36	1310	1220	1185	1150	1060	
AVPA42		1650	1585	1520	1450	1360
AVPA48		1900	1830	1760	1700	1620
AVPA60		1900	1830	1760	1700	1620

Air flow ratings of 208-230v. Units are at 230v. Air flow ratings of 480 v. units are at 460 volts. Operation of units at a different voltage from the rating point will affect air flow.

Electrical Characteristics - Compressor, Fan, Ventilation & Blower Motors - AVPA Heat Pumps

Model Number	COMPRESSOR			OTHER MOTORS	OUTDOOR FAN MOTOR			INDOOR BLOWER MOTOR			VENTILATION GREENWHEEL® ERV		
	VOLTS-HZ-PH	RLA ¹	LRA ²	VOLTS-HZ-PH	RPM ³	FLA ⁴	HP ⁵	RPM ³	FLA ⁴	HP ⁵	AMPS		
											OAM ⁶	EXM ⁷	WD ⁸
	AVPA24HPA	208/230-60-1	12.8	64.0	208/230-60-1	1075	1.5	1/5	1075	1.5	1/5	1.0	1.0
AVPA30HPA	208/230-60-1	14.1	77.0	208/230-60-1	1075	1.8	1/4	1075	2.5	1/4	1.0	1.0	0.2
AVPA36HPA	208/230-60-1	17.9	112.0	208/230-60-1	1075	1.8	1/4	1075	2.5	1/4	1.0	1.0	0.2
AVPA42HPA	208/230-60-1	19.8	109.0	208/230-60-1	825	2.8	1/3	1075	3.1	1/2	1.0	1.0	0.2
AVPA48HPA	208/230-60-1	21.8	117.0	208/230-60-1	825	2.8	1/3	1075	3.1	1/2	1.0	1.0	0.2
AVPA60HPA	208/230-60-1	26.2	134.0	208/230-60-1	825	2.8	1/3	1075	5.2	3/4	1.0	1.0	0.2
AVPA24HPC	208/230-60-3	8.3	61.0	208/230-60-1	1075	1.5	1/5	1075	1.5	1/5	1.0	1.0	0.2
AVPA30HPC	208/230-60-3	9.0	71.0	208/230-60-1	1075	1.8	1/4	1075	2.5	1/4	1.0	1.0	0.2
AVPA36HPC	208/230-60-3	13.2	88.0	208/230-60-1	1075	1.8	1/4	1075	2.5	1/4	1.0	1.0	0.2
AVPA42HPC	208/230-60-3	13.6	83.1	208/230-60-1	825	2.8	1/3	1075	3.1	1/2	1.0	1.0	0.2
AVPA48HPC	208/230-60-3	13.7	83.1	208/230-60-1	825	2.8	1/3	1075	3.1	1/2	1.0	1.0	0.2
AVPA60HPC	208/230-60-3	15.6	111.0	208/230-60-1	825	2.8	1/3	1075	5.2	3/4	1.0	1.0	0.2
AVPA24HPD	460-60-3	5.1	28.0	208/230-60-1	1075	1.5	1/5	1075	1.5	1/5	1.0	1.0	0.2
AVPA30HPD	460-60-3	5.6	38.0	208/230-60-1	1075	1.8	1/4	1075	2.5	1/4	1.0	1.0	0.2
AVPA36HPD	460-60-3	6.0	44.0	208/230-60-1	1075	1.8	1/4	1075	2.5	1/4	1.0	1.0	0.2
AVPA42HPD	460-60-3	6.1	41.0	208/230-60-1	825	2.8	1/3	1075	3.1	1/2	1.0	1.0	0.2
AVPA48HPD	460-60-3	6.2	41.0	208/230-60-1	825	2.8	1/3	1075	3.1	1/2	1.0	1.0	0.2
AVPA60HPD	460-60-3	7.7	52.0	208/230-60-1	825	2.8	1/3	1075	5.2	3/4	1.0	1.0	0.2

¹RLA = Rated Load Amps ²LRA = Locked Rotor Amps ³RPM = Revolutions per Minute ⁴FLA = Full Load Amps
⁵HP = Horsepower ⁶OAM = Outside Air Mover ⁷EXM = Exhaust Air Mover ⁸WD = Wheel Drive Motor

The 460 volt units have a step down transformer for the 230 volt motors.

Summary Electrical Ratings (Wire and HACR Circuit Breaker Sizing) - AVPA Heat Pumps with Ventilation Configurations:
Manual Damper, up to 15% outside air ("N")
Manual Damper, up to 450 cfm of outside air ("Y")
Manual Damper, up to 450 cfm of outside air with pressure relief ("Z")
Motorized 2-Position Damper, up to 450 cfm of outside air w/Pressure Relief ("B")
Economizer, Outside air with Pressure Relief ("C")

ELECTRIC HEAT		000 = None		040 = 4 kw		050 = 5 kw		060 = 6 kw		080 = 8 kw		090 = 9 kw		100 = 10 kw		120 = 12 kw		150 = 15 kw	
BASIC MODEL	VOLTS-HZ-PH	SPPE ³		SPPE ³		SPPE ³		SPPE ³		SPPE ³		SPPE ³		SPPE ³		SPPE ³		SPPE ³	
		MCA ¹	MFS ²	MCA ¹	MFS ²	MCA ¹	MFS ²	MCA ¹	MFS ²	MCA ¹	MFS ²	MCA ¹	MFS ²	MCA ¹	MFS ²	MCA ¹	MFS ²	MCA ¹	MFS ²
AVPA24HPA	208/230-1-60	19.0	30	39.9	40	45.0	50	50.3	60	60.6	70			71.1	80				
AVPA30HPA	208/230-1-60	21.9	35			47.9	50	53.2	60	63.5	70			74.0	80	84.4	90	100.0	100
AVPA36HPA	208/230-1-60	26.7	40			52.7	60	58.0	60	68.3	70			78.8	80	89.2	90	104.8	110
AVPA42HPA	208/230-1-60	30.7	50			56.7	60							82.8	90	93.2	100	108.8	110
AVPA48HPA	208/230-1-60	33.2	50			59.2	60							85.3	90	95.7	100	111.3	120
AVPA60HPA	208/230-1-60	40.8	60			66.8	70							92.9	100	103.3	110	118.9	120
AVPA24HPC	208/230-3-60	13.4	20					31.4	35			40.5	45						
AVPA30HPC	208/230-3-60	15.6	20					33.6	35			42.7	45			51.7	60	60.7	70
AVPA36HPC	208/230-3-60	20.8	30					38.8	40			47.9	50			56.9	60	65.9	70
AVPA42HPC	208/230-3-60	22.9	35					40.9	45			50.0	50			59.0	60	68.0	70
AVPA48HPC	208/230-3-60	23.0	35					41.0	45			50.1	60			59.1	60	68.1	70
AVPA60HPC	208/230-3-60	27.5	40					45.5	50			54.6	60			63.6	70	72.6	80
AVPA24HPD	460-3-60	7.9	15					16.9	20			21.4	25			25.9	30	30.4	35
AVPA30HPD	460-3-60	9.2	15					18.2	20			22.7	25			27.2	30	31.7	35
AVPA36HPD	460-3-60	9.7	15					18.7	20			23.2	25			27.7	30	32.2	35
AVPA42HPD	460-3-60	10.6	15					19.6	20			24.1	25			28.6	30	33.1	35
AVPA48HPD	460-3-60	10.7	15					19.7	20			24.2	25			28.7	30	33.2	35
AVPA60HPD	460-3-60	13.6	20					22.6	25			27.1	30			31.6	35	36.1	40

¹MCA = Minimum Circuit Ampacity (Wiring Size Amps) ²MFS = Maximum Fuse or HACR Breaker Size ³SPPE = Single Point Power Entry
MCA & MFS are calculated at 230 volts on the 208-230v. (HPA & HPC) models. The 460 volt HPD models are calculated at 460 volts. This chart should only be used as a guideline for estimating conductor size and overcurrent protection. For the requirements of specific units, always refer to the data label on the unit.

Summary Electrical Ratings (Wire and HACR Circuit Breaker Sizing) - AVPA Heat Pumps with the "S" Circuit and Ventilation Configuration:
Manual Damper, up to 15% outside air ("N")
Manual Damper, up to 450 cfm of outside air ("Y")
Manual Damper, up to 450 cfm of outside air with pressure relief ("Z")
Motorized 2-Position Damper, up to 450 cfm of outside air w/Pressure Relief ("B")
Economizer, Outside air with Pressure Relief ("C")

ELECTRIC HEAT		000 = None		040 = 4 kw		050 = 5 kw		060 = 6 kw		080 = 8 kw		090 = 9 kw		100 = 10 kw		120 = 12 kw		150 = 15 kw	
BASIC MODEL	VOLTS-HZ-PH	SPPE ³		SPPE ³		SPPE ³		SPPE ³		SPPE ³		SPPE ³		SPPE ³		SPPE ³		SPPE ³	
		MCA ¹	MFS ²	MCA ¹	MFS ²	MCA ¹	MFS ²	MCA ¹	MFS ²	MCA ¹	MFS ²	MCA ¹	MFS ²	MCA ¹	MFS ²	MCA ¹	MFS ²	MCA ¹	MFS ²
AVPA24HPA	208/230-1-60	19.0	30	20.3	30	27.5	30	32.8	35					53.6	60				
AVPA30HPA	208/230-1-60	21.9	35			28.5	35	33.8	35					54.6	60	65.0	70	80.6	90
AVPA36HPA	208/230-1-60	26.7	40			28.5	40	33.8	35					54.6	60	65.0	70	80.6	90
AVPA42HPA	208/230-1-60	30.7	50			30.7	50							55.2	60	65.6	70	81.2	90
AVPA48HPA	208/230-1-60	33.2	50			33.2	50							55.2	60	65.6	70	81.2	90
AVPA60HPA	208/230-1-60	40.8	60			40.8	60							57.3	60	67.7	70	83.3	90
AVPA24HPC	208/230-3-60	13.4	20					19.5	20			28.6	30			37.6	40	46.6	50
AVPA30HPC	208/230-3-60	15.6	20					20.5	25			29.6	30			38.6	40	47.6	50
AVPA36HPC	208/230-3-60	20.8	30					20.8	30			29.6	30			38.6	40	47.6	50
AVPA42HPC	208/230-3-60	22.9	35					22.9	35			30.2	35			39.2	40	48.2	50
AVPA48HPC	208/230-3-60	23.0	35					23.0	35			30.2	35			39.2	40	48.2	50
AVPA60HPC	208/230-3-60	27.5	40					27.5	40			32.3	40			41.3	45	50.3	60
AVPA24HPD	460-3-60	7.9	15					9.8	15			14.3	15			18.8	20	23.3	25
AVPA30HPD	460-3-60	9.2	15					10.3	15			14.8	15			19.3	20	23.8	25
AVPA36HPD	460-3-60	9.7	15					10.3	15			14.8	15			19.3	20	23.8	25
AVPA42HPD	460-3-60	10.6	15					10.6	15			15.1	20			19.6	20	24.1	25
AVPA48HPD	460-3-60	10.7	15					10.7	15			15.1	20			19.6	20	24.1	25
AVPA60HPD	460-3-60	13.6	20					13.6	20			16.1	20			20.6	25	25.1	30

"S" Circuit - Compressor and electric heat can NOT operate simultaneously.
¹MCA = Minimum Circuit Ampacity (Wiring Size Amps) ²MFS = Maximum Fuse or HACR Breaker Size ³SPPE = Single Point Power Entry
MCA & MFS are calculated at 230 volts on the 208-230v. (HPA & HPC) models. The 460 volt HPD models are calculated at 460 volts. This chart should only be used as a guideline for estimating conductor size and overcurrent protection. For the requirements of specific units, always refer to the data label on the unit.

Summary Electrical Ratings (Wire and HACR Circuit Breaker Sizing) - AVPA Heat Pumps Ratings and GreenWheel® Energy Recovery Ventilator - Ventilation Configuration ("H")

ELECTRIC HEAT		000 = None		040 = 4 kw		050 = 5 kw		060 = 6 kw		080 = 8 kw		090 = 9 kw		100 = 10 kw		120 = 12 kw		150 = 15 kw	
		SPPE ³		SPPE ³		SPPE ³		SPPE ³		SPPE ³		SPPE ³		SPPE ³		SPPE ³		SPPE ³	
BASIC MODEL	VOLTS-HZ-PH	MCA ¹	MFS ²	MCA ¹	MFS ²	MCA ¹	MFS ²	MCA ¹	MFS ²	MCA ¹	MFS ²	MCA ¹	MFS ²	MCA ¹	MFS ²	MCA ¹	MFS ²	MCA ¹	MFS ²
AVPA24HPA	208/230-1-60	21.2	30	42.1	45	47.2	50	52.5	60	62.8	70			73.3	80				
AVPA30HPA	208/230-1-60	24.1	35			49.1	50	55.4	60	65.7	70			76.2	80	86.6	90	102.2	110
AVPA36HPA	208/230-1-60	28.9	45			54.9	60	60.2	70	70.5	80			81.0	90	91.4	100	107.0	110
AVPA42HPA	208/230-1-60	32.9	50			58.9	60							85.0	90	95.4	100	111.0	120
AVPA48HPA	208/230-1-60	35.4	50			61.4	70							87.5	90	97.9	100	113.5	120
AVPA60HPA	208/230-1-60	43.0	60			69.0	70							95.1	100	105.5	110	121.1	130
AVPA24HPC	208/230-3-60	15.6	20					33.6	35			42.7	45						
AVPA30HPC	208/230-3-60	17.8	25					35.8	35			44.9	45			53.9	60	62.9	70
AVPA36HPC	208/230-3-60	23.0	35					41.0	45			50.1	60			59.1	60	68.1	70
AVPA42HPC	208/230-3-60	25.1	35					43.1	45			52.2	60			61.2	70	70.2	80
AVPA48HPC	208/230-3-60	25.2	35					43.2	45			52.3	60			61.3	70	70.3	80
AVPA60HPC	208/230-3-60	29.7	45					47.7	50			56.8	60			65.8	70	74.8	80
AVPA24HPD	460-3-60	9.0	15					18.0	20			22.5	25			27.0	30	31.5	35
AVPA30HPD	460-3-60	10.3	15					19.3	20			23.8	25			28.3	30	32.8	35
AVPA36HPD	460-3-60	10.8	15					19.8	20			24.3	25			28.8	30	33.3	35
AVPA42HPD	460-3-60	11.7	15					20.7	20			25.2	30			29.7	30	34.2	35
AVPA48HPD	460-3-60	11.8	15					20.8	20			25.3	30			29.8	30	34.3	35
AVPA60HPD	460-3-60	14.7	20					23.7	25			28.2	30			32.7	35	37.2	40

¹MCA = Minimum Circuit Ampacity (Wiring Size Amps) ²MFS = Maximum Fuse or HACR Breaker Size ³SPPE = Single Point Power Entry
MCA & MFS are calculated at 230 volts on the 208-230v. (HPA & HPC) models. The 460 volt HPD models are calculated at 460 volts. This chart should only be used as a guideline for estimating conductor size and overcurrent protection. For the requirements of specific units, always refer to the data label on the unit.

Summary Electrical Ratings (Wire and HACR Circuit Breaker Sizing) - AVPA Heat Pumps with the "S" Circuit and GreenWheel® Energy Recovery Ventilator - Ventilation Configuration ("H")

ELECTRIC HEAT		000 = None		040 = 4 kw		050 = 5 kw		060 = 6 kw		080 = 8 kw		090 = 9 kw		100 = 10 kw		120 = 12 kw		150 = 15 kw	
		SPPE ³		SPPE ³		SPPE ³		SPPE ³		SPPE ³		SPPE ³		SPPE ³		SPPE ³		SPPE ³	
BASIC MODEL	VOLTS-HZ-PH	MCA ¹	MFS ²	MCA ¹	MFS ²	MCA ¹	MFS ²	MCA ¹	MFS ²	MCA ¹	MFS ²	MCA ¹	MFS ²	MCA ¹	MFS ²	MCA ¹	MFS ²	MCA ¹	MFS ²
AVPA24HPA	208/230-1-60	21.2	30	22.5	30	29.7	30	35.0	35					55.8	60				
AVPA30HPA	208/230-1-60	24.1	35			30.7	35	36.0	40					56.8	60	67.2	70	80.6	90
AVPA36HPA	208/230-1-60	28.9	45			30.7	45	36.0	45					56.8	60	67.2	70	80.6	90
AVPA42HPA	208/230-1-60	32.9	50			32.9	50							57.4	60	67.8	70	81.2	90
AVPA48HPA	208/230-1-60	35.4	50			35.4	50							57.4	60	67.8	70	81.2	90
AVPA60HPA	208/230-1-60	43.0	60			43.0	60							59.5	60	69.9	70	83.3	90
AVPA24HPC	208/230-3-60	15.6	20					21.7	25			30.8	35			39.8	40	46.6	50
AVPA30HPC	208/230-3-60	17.8	25					22.7	25			31.8	35			40.8	45	47.6	50
AVPA36HPC	208/230-3-60	23.0	35					23.0	30			31.8	35			40.8	45	47.6	50
AVPA42HPC	208/230-3-60	25.1	35					25.1	35			32.4	35			41.4	45	48.2	50
AVPA48HPC	208/230-3-60	25.2	35					25.2	35			32.4	35			41.4	45	48.2	50
AVPA60HPC	208/230-3-60	29.7	45					29.7	45			34.5	45			43.5	45	50.3	60
AVPA24HPD	460-3-60	9.0	15					10.9	15			15.4	20			19.9	20	24.4	25
AVPA30HPD	460-3-60	10.3	15					11.4	15			15.9	20			20.4	25	24.9	25
AVPA36HPD	460-3-60	10.8	15					11.4	15			15.9	20			20.4	25	24.9	25
AVPA42HPD	460-3-60	11.7	15					11.7	15			16.2	20			20.7	25	25.2	30
AVPA48HPD	460-3-60	11.8	15					11.8	15			16.2	20			20.7	25	25.2	30
AVPA60HPD	460-3-60	14.7	20					14.7	20			17.2	20			21.7	25	26.2	30

"S" Circuit - Compressor and electric heat can NOT operate simultaneously.
¹MCA = Minimum Circuit Ampacity (Wiring Size Amps) ²MFS = Maximum Fuse or HACR Breaker Size ³SPPE = Single Point Power Entry
MCA & MFS are calculated at 230 volts on the 208-230v. (HPA & HPC) models. The 460 volt HPD models are calculated at 460 volts. This chart should only be used as a guideline for estimating conductor size and overcurrent protection. For the requirements of specific units, always refer to the data label on the unit.

Unit Load Amps (Heating) - AVPA Heat Pumps with Ventilation Configurations:
Manual Damper, up to 15% outside air ("N")
Manual Damper, up to 450 cfm of outside air ("Y")
Manual Damper, up to 450 cfm of outside air with pressure relief ("Z")
Motorized 2-Position Damper, up to 450 cfm of outside air w/Pressure Relief ("B")
Economizer, Outside air with Pressure Relief ("C")

MODEL NUMBER	VOLTAGE PHASE HERTZ	CURRENT (AMPS)		LOAD OF RESISTIVE HEATING - ELEMENTS ONLY (AMPS) (1) ALL HEATING ELEMENTS ARE ON A SEPARATE CIRCUIT (2) SHADED VALUES (12 & 15 kW) UTILIZE TWO CIRCUITS										TOTAL MAXIMUM HEATING AMPS INCLUDES AMPS FROM MOTOR(S) THAT ARE LOCATED ON AN ELECTRICAL CIRCUIT THAT DOES NOT HAVE HEATERS							
		HP ¹	IBM ²	04 kW	05 kW	06 kW	08 kW	09 kW	10 kW	12 kW	15 kW	04 Kw	05 Kw	06 Kw	08 Kw	09 Kw	10 Kw	12 Kw	15 Kw		
AVPA24HPA	208-230/1/60	15.8	1.5	16.7	20.8	25.0	33.3		41.7						32.5	36.6	40.8	49.1	57.5		
AVPA30HPA	208-230/1/60	18.4	2.5	16.7	20.8	25.0	33.3		41.7	50.0	62.5	35.1	39.2	43.4	51.7		60.1	68.4	80.9		
AVPA36HPA	208-230/1/60	22.2	2.5	16.7	20.8	25.0	33.3		41.7	50.0	62.5	38.9	43.0	47.2	55.5		63.9	72.2	84.7		
AVPA42HPA	208-230/1/60	25.7	3.1		20.8				41.7	50.0	62.5		46.5				67.4	75.7	88.2		
AVPA48HPA	208-230/1/60	27.7	3.1		20.8				41.7	50.0	62.5		48.5				69.4	77.7	90.2		
AVPA60HPA	208-230/1/60	34.2	5.2		20.8				41.7	50.0	62.5		55.0				75.9	84.2	96.7		
AVPA24HPC	208-230/3/60	11.2	1.5			14.4		21.7		28.9	36.1				25.6		32.9		40.1	47.3	
AVPA30HPC	208-230/3/60	13.3	2.5			14.4		21.7		28.9	36.1				27.7		35.0		42.2	49.4	
AVPA36HPC	208-230/3/60	17.5	2.5			14.4		21.7		28.9	36.1				31.9		39.2		46.4	53.6	
AVPA42HPC	208-230/3/60	19.5	3.1			14.4		21.7		28.9	36.1				33.9		41.2		48.4	55.6	
AVPA48HPC	208-230/3/60	19.6	3.1			14.4		21.7		28.9	36.1				34.0		41.3		48.5	55.7	
AVPA60HPC	208-230/3/60	23.6	5.2			14.4		21.7		28.9	36.1				38.0		45.3		52.5	59.7	
AVPA24HPD	460/3/60	6.6	0.8			7.2		10.8		14.4	18.0				13.8		17.4		21.0	24.6	
AVPA30HPD	460/3/60	7.8	1.3			7.2		10.8		14.4	18.0				15.0		18.6		22.2	25.8	
AVPA36HPD	460/3/60	8.2	1.3			7.2		10.8		14.4	18.0				15.4		19.0		22.6	26.2	
AVPA42HPD	460/3/60	9.1	1.6			7.2		10.8		14.4	18.0				16.3		19.9		23.5	27.1	
AVPA48HPD	460/3/60	9.2	1.6			7.2		10.8		14.4	18.0				16.4		20.0		23.6	27.2	
AVPA60HPD	460/3/60	11.7	2.6			7.2		10.8		14.4	18.0				18.9		22.5		26.1	29.7	

¹HP = Heat Pump Unit Amps (includes Indoor Motor amps) ²IBM = Indoor Blower Motor
 Heating kW is rated at 240 volts on the 208-230v. (HPA & HPC) models. Derate heater output by 25% for operation at 208 volts. Heating kW is rated at 480 volts on the HPD models.
 Total heating amps for single phase units with two circuits (#1 and #2) includes both circuits. Total heating and cooling amps includes all motors. Three phase models contain single phase motor loads.
 Values shown are maximum phase loads. Loads are not equally balanced on each phase.

Unit Load Amps (Heating) - AVPA Heat Pumps with GreenWheel® Energy Recovery Ventilator - Ventilation Configuration ("H")

MODEL NUMBER	VOLTAGE PHASE HERTZ	CURRENT (AMPS)			LOAD OF RESISTIVE HEATING - ELEMENTS ONLY (AMPS) (1) ALL HEATING ELEMENTS ARE ON A SEPARATE CIRCUIT (2) SHADED VALUES (12 & 15 kW) UTILIZE TWO CIRCUITS										TOTAL MAXIMUM HEATING AMPS INCLUDES AMPS FROM MOTOR(S) THAT ARE LOCATED ON AN ELECTRICAL CIRCUIT THAT DOES NOT HAVE HEATERS							
		HP ¹	IBM ²	H ³	04 kW	05 kW	06 kW	08 kW	09 kW	10 kW	12 kW	15 kW	04 Kw	05 Kw	06 Kw	08 Kw	09 Kw	10 Kw	12 Kw	15 Kw		
AVPA24HPA	208-230/1/60	18.0	1.5	2.2	16.7	20.8	25.0	33.3		41.7					18.2	38.8	43.0	51.3	59.7			
AVPA30HPA	208-230/1/60	20.6	2.5	2.2	16.7	20.8	25.0	33.3		41.7	50.0	62.5	19.2	41.4	45.6	53.9		62.3	70.6	83.1		
AVPA36HPA	208-230/1/60	24.4	2.5	2.2	16.7	20.8	25.0	33.3		41.7	50.0	62.5	19.2	45.2	49.4	57.7		66.1	74.4	86.9		
AVPA42HPA	208-230/1/60	27.9	3.1	2.2		20.8				41.7	50.0	62.5		48.7				69.6	77.9	90.4		
AVPA48HPA	208-230/1/60	29.9	3.1	2.2		20.8				41.7	50.0	62.5		50.7				71.6	79.9	92.4		
AVPA60HPA	208-230/1/60	36.4	5.2	2.2		20.8				41.7	50.0	62.5		57.2				78.1	86.4	98.9		
AVPA24HPC	208-230/3/60	13.4	1.5	2.2			14.4		21.7		28.9	36.1			27.8		35.1		42.3	49.5		
AVPA30HPC	208-230/3/60	15.5	2.5	2.2			14.4		21.7		28.9	36.1			29.9		37.2		44.4	51.6		
AVPA36HPC	208-230/3/60	19.7	2.5	2.2			14.4		21.7		28.9	36.1			34.1		41.4		48.6	55.8		
AVPA42HPC	208-230/3/60	21.7	3.1	2.2			14.4		21.7		28.9	36.1			36.1		43.4		50.6	57.8		
AVPA48HPC	208-230/3/60	21.8	3.1	2.2			14.4		21.7		28.9	36.1			36.2		43.5		50.7	57.9		
AVPA60HPC	208-230/3/60	25.8	5.2	2.2			14.4		21.7		28.9	36.1			40.2		47.5		54.7	61.9		
AVPA24HPD	460/3/60	7.7	0.8	1.1			7.2		10.8		14.4	18.0			14.9		18.5		22.1	25.7		
AVPA30HPD	460/3/60	8.9	1.3	1.1			7.2		10.8		14.4	18.0			16.1		19.7		23.3	26.9		
AVPA36HPD	460/3/60	9.3	1.3	1.1			7.2		10.8		14.4	18.0			16.5		20.1		23.7	27.3		
AVPA42HPD	460/3/60	10.2	1.6	1.1			7.2		10.8		14.4	18.0			17.4		21.0		24.6	28.2		
AVPA48HPD	460/3/60	10.3	1.6	1.1			7.2		10.8		14.4	18.0			17.5		21.1		24.7	28.3		

¹HP = Heat Pump Unit Amps (includes Indoor Motor amps) ²IBM = Indoor Blower Motor ³H = GreenWheel ERV
 Heating kW is rated at 240 volts on the 208-230v. (HPA & HPC) models. Derate heater output by 25% for operation at 208 volts. Heating kW is rated at 480 volts on the HPD models.
 Total heating amps for single phase units with two circuits (#1 and #2) includes both circuits. Total heating and cooling amps includes all motors. Three phase models contain single phase motor loads. Values shown are maximum phase loads. Loads are not equally balanced on each phase.

Certified Efficiency and Capacity Ratings at ANSI/ARI Standard 390 - for HVPA Heat Pumps with Single Stage Compressor

Model Number	HVPA24HP1			HVPA30			HVPA36			HVPA42HP1			HVPA49			HVPA60		
	HPA	HPC	HPD	HPA	HPC	HPD	HPA	HPC	HPD	HPA	HPC	HPD	HPA	HPC	HPD	HPA	HPC	HPD
Cooling BTUH¹	23,600			28,000			34,600			40,500			47,000			56,500		
EER²	11.00			11.50			11.00			10.50			11.50			10.50		
High Temperature Heating³	23,000			26,000			33,000			39,000			42,000			51,000		
High Temperature COP^{3,4}	3.25			3.00			3.25			3.25			3.25			3.00		
Rated Air Flow (CFM⁵)	800			1,000			1,200			1,300			1,750			1,750		

¹Cooling is rated at 95°F (35°C) outdoor and 80°F DB/67°F WB (26.5°C DB/19.5°C WB) return air.

²EER = Energy Efficiency Ratio

³High Temperature Heating & COP is rated at 47°F DB/43°WB (8.3°C DB/6.1°C WB) outdoor and 70°F (21.1°C) return air.

⁴COP = Coefficient of Performance

⁵CFM = Cubic Feet per Minute

Ratings are with no outside air. Performance will be affected by altitude. Ratings are at 230 volts for 208/230 volt units ("A" & "C" models) and 460 volts for "D" models.

Operation of units at a different voltage from that of the rating point will affect performance and air flow.

Sensible Total Heat Ratio @ 95°F (35°C) Outside Air DB - HVPA Heat Pumps with Single Stage Compressor

Model Number	HVPA24HP1			HVPA30			HVPA36			HVPA42HP1			HVPA49			HVPA60		
	HPA	HPC	HPD	HPA	HPC	HPD	HPA	HPC	HPD	HPA	HPC	HPD	HPA	HPC	HPD	HPA	HPC	HPD
Total Capacity	23,600			28,000			34,600			40,500			47,000			56,500		
Sensible Heat Ratio	0.74			0.73			0.74			0.70			0.75			0.71		
Sensible Capacity	17,435			20,460			25,490			28,415			35,200			40,295		
Rated Air Flow (CFM¹)	800			1,000			1,200			1,300			1,750			1,750		

¹CFM = Cubic Feet per Minute

Sensible Heat Ratios based upon ANSI/AHRI std. 390 outdoor conditions of 95°F (35°C) outdoor and 80°F DB/67°F WB (26.5°C DB/19.5°C WB) return air.

Cooling Performance (BTUH) at Various Outdoor Temperatures - HVPA Heat Pumps with Single Stage Compressor

Model Number	Outdoor Temperature									
	75°F/24°C	80°F/26.5°C	85°F/29°C	90°F/32°C	95°F/35°C	100°F/38°C	105°F/40.5°C	110°F/43.3°C	115°F/46°C	
HVPA24HP1	27,375	26,430	25,490	24,545	23,600	22,655	21,710	20,770	20,295	
HVPA30HP	32,480	31,360	30,240	29,120	28,000	26,880	25,760	24,640	24,080	
HVPA36HP	40,135	38,750	37,370	35,985	34,600	33,215	31,830	30,450	29,755	
HVPA42HP1	46,980	45,360	43,740	42,120	40,500	38,880	37,260	35,640	34,830	
HVPA49HP	54,520	52,640	50,760	48,880	47,000	45,120	43,240	41,360	40,420	
HVPA60HP	65,540	63,280	61,020	58,760	56,500	54,240	51,980	49,720	48,590	

Based upon ANSI/AHRI std. 390 return air conditions of 80°F DB/67°F WB (26.5°C DB/19.5°C WB). Return air at rated air flow.

Heating Performance (BTUH) at Various Outdoor Temperatures - HVPA Heat Pumps with Single Stage Compressor

Model Number	Outdoor Temperature									
	10°F / -12.2°C	17°F / -8.3°C	20°F / -6.7°C	30°F / -1.1°C	40°F / 4.4°C	47°F / 8.3°C	50°F / 10°C	60°F / 15.6°C	70°F / 21.1°C	
HVPA24HP1	9,775	11,500	12,650	16,675	20,125	23,000	23,690	24,725	25,875	
HVPA30HP	12,410	14,600	15,740	19,730	23,150	26,000	26,780	27,950	29,250	
HVPA36HP	14,110	16,600	18,240	23,980	28,900	33,000	33,990	35,475	37,125	
HVPA42HP1	16,150	19,000	21,000	28,000	34,000	39,000	40,170	41,925	43,875	
HVPA49HP	20,060	23,600	25,440	31,880	37,400	42,000	43,260	45,150	47,250	
HVPA60HP	23,800	28,000	30,300	38,350	45,250	51,000	52,530	54,825	57,375	

Based upon ANSI/AHRI std. 390 return air conditions of 70°F DB (21.1°C DB). Return air at rated air flow.

Electrical Characteristics - Compressor, Fan, Ventilation & Blower Motors - HVPA Heat Pumps with Single Stage Compressor

Model Number	COMPRESSOR			OTHER MOTORS	OUTDOOR FAN MOTOR			INDOOR BLOWER MOTOR (ECM)			VENTILATION GREENWHEEL® ERV		
	VOLTS-HZ-PH	RLA ¹	LRA ²	VOLTS-HZ-PH	RPM ³	FLA ⁴	HP ⁵	RPM ³	FLA ⁴	HP ⁵	AMPS		
											OAM ⁶	EXM ⁷	WD ⁸
HVPA24HPA	208/230-60-1	12.8	64.0	208/230-60-1	825	1.8	1/4	1500	2.8	1/3	1.0	1.0	0.2
HVPA30HPA	208/230-60-1	12.8	77.0	208/230-60-1	825	2.8	1/3	1500	2.8	1/2	1.0	1.0	0.2
HVPA36HPA	208/230-60-1	16.6	112.0	208/230-60-1	825	2.8	1/3	1500	2.8	1/2	1.0	1.0	0.2
HVPA42HPA	208/230-60-1	19.8	109.0	208/230-60-1	825	2.8	1/3	1500	2.8	1/2	1.0	1.0	0.2
HVPA48HPA	208/230-60-1	21.8	117.0	208/230-60-1	825	2.8	1/2	1500	4.3	3/4	1.0	1.0	0.2
HVPA60HPA	208/230-60-1	26.2	134.0	208/230-60-1	825	2.8	1/2	1500	4.3	3/4	1.0	1.0	0.2
HVPA24HPC	208/230-60-3	7.7	61.0	208/230-60-1	825	1.8	1/4	1500	2.8	1/3	1.0	1.0	0.2
HVPA30HPC	208/230-60-3	8.3	71.0	208/230-60-1	825	2.8	1/3	1500	2.8	1/2	1.0	1.0	0.2
HVPA36HPC	208/230-60-3	10.4	88.0	208/230-60-1	825	2.8	1/3	1500	2.8	1/2	1.0	1.0	0.2
HVPA42HPC	208/230-60-3	13.6	83.1	208/230-60-1	825	2.8	1/3	1500	2.8	1/2	1.0	1.0	0.2
HVPA48HPC	208/230-60-3	13.7	83.1	208/230-60-1	825	2.8	1/2	1500	4.3	3/4	1.0	1.0	0.2
HVPA60HPC	208/230-60-3	15.6	111.0	208/230-60-1	825	2.8	1/2	1500	4.3	3/4	1.0	1.0	0.2
HVPA24HPD	460-60-3	4.0	28.0	208/230-60-1	825	1.8	1/4	1500	2.8	1/3	1.0	1.0	0.2
HVPA30HPD	460-60-3	5.1	38.0	208/230-60-1	825	2.8	1/3	1500	2.8	1/2	1.0	1.0	0.2
HVPA36HPD	460-60-3	5.8	44.0	208/230-60-1	825	2.8	1/3	1500	2.8	1/2	1.0	1.0	0.2
HVPA42HPD	460-60-3	6.1	41.0	208/230-60-1	825	2.8	1/3	1500	2.8	1/2	1.0	1.0	0.2
HVPA48HPD	460-60-3	6.2	41.0	208/230-60-1	825	2.8	1/2	1500	4.3	3/4	1.0	1.0	0.2
HVPA60HPD	460-60-3	7.7	52.0	208/230-60-1	825	2.8	1/2	1500	4.3	3/4	1.0	1.0	0.2

¹RLA = Rated Load Amps ²LRA = Locked Rotor Amps ³RPM = Revolutions per Minute ⁴FLA = Full Load Amps
⁵HP = Horsepower ⁶OAM = Outside Air Mover ⁷EXM = Exhaust Air Mover ⁸WD = Wheel Drive Motor
 The 460 volt units have a step down transformer for the 230 volt motors.

Summary Electrical Ratings (Wire and HACR Circuit Breaker Sizing) - HVPA Heat Pumps w/Single Stage Compressor & Ventilation Configuration: Manual Damper, up to 15% outside air ("N") Manual Damper, up to 450 cfm of outside air ("Y") Manual Damper, up to 450 cfm of outside air with pressure relief ("Z") Motorized, 2-Position Damper, up to 450 CFM of Outside Air w/Pressure Relief ("B") Economizer, Outside Air ("C")

ELECTRIC HEAT		000 = None		040 = 4 kw		050 = 5 kw		060 = 6 kw		080 = 8 kw		090 = 9 kw		100 = 10 kw		120 = 12 kw		150 = 15 kw		
BASIC MODEL	VOLTS-HZ-PH	SPPE ³		SPPE ³		SPPE ³		SPPE ³		SPPE ³		SPPE ³		SPPE ³		SPPE ³		SPPE ³		
		MCA ¹	MFS ²	MCA ¹	MFS ²	MCA ¹	MFS ²	MCA ¹	MFS ²	MCA ¹	MFS ²	MCA ¹	MFS ²	MCA ¹	MFS ²	MCA ¹	MFS ²	MCA ¹	MFS ²	
HVPA24HPA	208/230-1-60	20.6	30	41.5	45	46.6	50	51.9	60	62.2	70			72.7	80					
HVPA30HPA	208/230-1-60	21.6	30			47.6	50	52.9	60	63.2	70			73.7	80	84.1	90	99.7	100	
HVPA36HPA	208/230-1-60	26.4	40			52.4	60	57.7	60	68.0	70			78.5	80	88.9	90	104.5	110	
HVPA42HPA	208/230-1-60	30.4	50			56.4	60							82.5	90	92.9	100	108.5	110	
HVPA48HPA	208/230-1-60	34.4	50			60.4	70							86.5	90	96.9	100	112.5	120	
HVPA60HPA	208/230-1-60	39.9	60			65.9	70							92.0	100	102.4	110	118.0	120	
HVPA24HPC	208/230-3-60	14.2	20					32.2	35				41.3	45						
HVPA30HPC	208/230-3-60	16.0	20					34.0	35				43.1	45			52.1	60	61.1	70
HVPA36HPC	208/230-3-60	18.6	25					36.6	40				45.7	50			54.7	60	63.7	70
HVPA42HPC	208/230-3-60	22.6	35					40.6	45				49.7	50			58.7	60	67.7	70
HVPA48HPC	208/230-3-60	24.2	35					42.2	45				51.3	60			60.3	70	69.3	70
HVPA60HPC	208/230-3-60	26.6	40					44.6	45				53.7	60			62.7	70	71.7	80
HVPA24HPD	460-3-60	7.3	15					16.3	20				20.8	25			25.3	30	29.8	30
HVPA30HPD	460-3-60	9.2	15					18.2	20				22.7	25			27.2	30	31.7	35
HVPA36HPD	460-3-60	10.1	15					19.1	20				23.6	25			28.1	30	32.6	35
HVPA42HPD	460-3-60	10.4	15					19.4	20				23.9	25			28.4	30	32.9	35
HVPA48HPD	460-3-60	11.3	15					20.3	25				24.8	25			29.3	30	33.8	35
HVPA60HPD	460-3-60	13.2	20					22.2	25				26.7	30			31.2	35	35.7	40

¹MCA = Minimum Circuit Ampacity (Wiring Size Amps) ²MFS = Maximum Fuse or HACR Breaker Size ³SPPE = Single Point Power Entry
 MCA & MFS are calculated at 230 volts on the 208-230v. (HPA & HPC) models. The 460 volt HPD models are calculated at 460 volts. This chart should only be used as a guideline for estimating conductor size and overcurrent protection. For the requirements of specific units, always refer to the data label on the unit.

Summary Electrical Ratings (Wire and HACR Circuit Breaker Sizing) - HVPA Heat Pumps with Single Stage Compressor and "S" Circuit and Ventilation Configurations:

Manual Damper, up to 15% outside air ("N")

Manual Damper, up to 450 cfm of outside air ("Y")

Manual Damper, up to 450 cfm of outside air with pressure relief ("Z")

Motorized, 2-Position Damper, up to 450 CFM of Outside Air w/Pressure Relief ("B")

Economizer, Outside Air ("C")

ELECTRIC HEAT		000 = None		040 = 4 kw		050 = 5 kw		060 = 6 kw		080 = 8 kw		090 = 9 kw		100 = 10 kw		120 = 12 kw		150 = 15 kw	
BASIC MODEL	VOLTS-HZ-PH	SPPE ³		SPPE ³		SPPE ³		SPPE ³		SPPE ³		SPPE ³		SPPE ³		SPPE ³		SPPE ³	
		MCA ¹	MFS ²	MCA ¹	MFS ²	MCA ¹	MFS ²	MCA ¹	MFS ²	MCA ¹	MFS ²	MCA ¹	MFS ²	MCA ¹	MFS ²	MCA ¹	MFS ²	MCA ¹	MFS ²
HVPA24HPA	208/230-1-60	20.6	30	23.7	30	28.8	30	34.1	35					54.9	60				
HVPA30HPA	208/230-1-60	21.6	30			28.8	30	34.1	35					54.9	60	65.3	70	80.9	90
HVPA36HPA	208/230-1-60	26.4	40			28.8	40	34.1	40					54.9	60	65.3	70	80.9	90
HVPA42HPA	208/230-1-60	30.4	50			30.4	50							54.9	60	65.3	70	80.9	90
HVPA48HPA	208/230-1-60	34.4	50			34.4	50							56.4	60	66.8	70	82.4	90
HVPA60HPA	208/230-1-60	39.9	60			39.9	60							56.4	60	66.8	70	82.4	90
HVPA24HPC	208/230-3-60	14.2	20					20.8	25			29.9	30			38.9	40	47.9	50
HVPA30HPC	208/230-3-60	16.0	20					20.8	25			29.9	30			38.9	40	47.9	50
HVPA36HPC	208/230-3-60	18.6	25					20.8	25			29.9	30			38.9	40	47.9	50
HVPA42HPC	208/230-3-60	22.6	35					20.8	35			29.9	35			38.9	40	47.9	50
HVPA48HPC	208/230-3-60	24.2	35					24.2	35			31.4	35			40.4	45	49.4	50
HVPA60HPC	208/230-3-60	26.6	40					26.6	40			31.4	40			40.4	45	49.4	50
HVPA24HPD	460-3-60	7.3	15					10.4	15			14.9	15			19.4	20	23.9	25
HVPA30HPD	460-3-60	9.2	15					10.4	15			14.9	15			19.4	20	23.9	25
HVPA36HPD	460-3-60	10.1	15					10.4	15			14.9	15			19.4	20	23.9	25
HVPA42HPD	460-3-60	10.4	15					10.4	15			14.9	15			19.4	20	23.9	25
HVPA48HPD	460-3-60	11.3	15					11.3	15			15.7	20			20.2	25	24.7	25
HVPA60HPD	460-3-60	13.2	20					13.2	20			15.7	20			20.2	25	24.7	25

S-Circuit - Compressor and electric heat do NOT operate simultaneously.

¹MCA = Minimum Circuit Ampacity (Wiring Size Amps) ²MFS = Maximum Fuse or HACR Breaker Size ³SPPE = Single Point Power Entry

MCA & MFS are calculated at 230 volts on the 208-230v. (HPA & HPC) models. The 460 volt HPD models are calculated at 460 volts. This chart should only be used as a guideline for estimating conductor size and overcurrent protection. For the requirements of specific units, always refer to the data label on the unit.

Summary Electrical Ratings (Wire and HACR Circuit Breaker Sizing) - HVPA Heat Pumps with Single Stage Compressor and GreenWheel® ERV - Ventilation Configuration ("H")

ELECTRIC HEAT		000 = None		040 = 4 kw		050 = 5 kw		060 = 6 kw		080 = 8 kw		090 = 9 kw		100 = 10 kw		120 = 12 kw		150 = 15 kw	
BASIC MODEL	VOLTS-HZ-PH	SPPE ³		SPPE ³		SPPE ³		SPPE ³		SPPE ³		SPPE ³		SPPE ³		SPPE ³		SPPE ³	
		MCA ¹	MFS ²	MCA ¹	MFS ²	MCA ¹	MFS ²	MCA ¹	MFS ²	MCA ¹	MFS ²	MCA ¹	MFS ²	MCA ¹	MFS ²	MCA ¹	MFS ²	MCA ¹	MFS ²
HVPA24HPA	208/230-1-60	22.8	35	43.7	45	48.8	50	54.1	60	64.4	70			74.9	80				
HVPA30HPA	208/230-1-60	23.8	35			49.8	50	55.1	60	65.1	70			75.9	80	86.3	90	101.9	110
HVPA36HPA	208/230-1-60	28.6	40			54.6	60	59.9	60	70.2	80			80.7	90	91.1	100	106.7	110
HVPA42HPA	208/230-1-60	32.6	50			58.6	60							84.7	90	95.1	100	110.7	120
HVPA48HPA	208/230-1-60	36.6	50			62.6	70							88.7	90	99.1	100	114.7	120
HVPA60HPA	208/230-1-60	42.1	60			68.1	70							94.2	100	104.6	110	120.2	130
HVPA24HPC	208/230-3-60	16.4	20					34.4	35			43.5	45						
HVPA30HPC	208/230-3-60	18.2	25					36.2	40			45.3	50			54.3	60	63.3	70
HVPA36HPC	208/230-3-60	20.8	25					38.8	40			47.9	50			56.9	60	65.9	70
HVPA42HPC	208/230-3-60	24.8	35					42.8	45			51.9	60			60.9	70	69.9	70
HVPA48HPC	208/230-3-60	26.4	35					44.4	45			53.5	60			62.5	70	71.5	80
HVPA60HPC	208/230-3-60	28.8	40					46.8	50			55.9	60			64.9	70	73.9	80
HVPA24HPD	460-3-60	8.4	15					17.4	20			21.9	25			26.4	30	30.9	35
HVPA30HPD	460-3-60	10.3	15					19.3	20			23.8	25			28.3	30	32.8	35
HVPA36HPD	460-3-60	11.2	15					20.2	25			24.7	25			29.2	30	33.7	35
HVPA42HPD	460-3-60	11.5	15					20.5	25			25.0	25			29.5	30	34.0	35
HVPA48HPD	460-3-60	12.4	15					21.4	25			25.9	30			30.4	35	34.9	35
HVPA60HPD	460-3-60	14.3	20					23.3	25			27.8	30			32.3	35	36.8	40

¹MCA = Minimum Circuit Ampacity (Wiring Size Amps) ²MFS = Maximum Fuse or HACR Breaker Size ³SPPE = Single Point Power Entry

MCA & MFS are calculated at 230 volts on the 208-230v. (HPA & HPC) models. The 460 volt HPD models are calculated at 460 volts. This chart should only be used as a guideline for estimating conductor size and overcurrent protection. For the requirements of specific units, always refer to the data label on the unit.

Summary Electrical Ratings (Wire and HACR Circuit Breaker Sizing) - HVPA Heat Pumps w/Single Stage Compressor & "S" Circuit & GreenWheel® ERV - Ventilation Configuration ("H")

ELECTRIC HEAT		000 = None		040 = 4 kw		050 = 5 kw		060 = 6 kw		080 = 8 kw		090 = 9 kw		100 = 10 kw		120 = 12 kw		150 = 15 kw	
BASIC MODEL	VOLTS-HZ-PH	SPPE ³		SPPE ³		SPPE ³		SPPE ³		SPPE ³		SPPE ³		SPPE ³		SPPE ³		SPPE ³	
		MCA ¹	MFS ²	MCA ¹	MFS ²	MCA ¹	MFS ²	MCA ¹	MFS ²	MCA ¹	MFS ²	MCA ¹	MFS ²	MCA ¹	MFS ²	MCA ¹	MFS ²	MCA ¹	MFS ²
HVPA24HPA	208/230-1-60	22.8	35	25.9	30	31.0	35	36.3	40					57.1	60				
HVPA30HPA	208/230-1-60	23.8	35			31.0	35	36.3	40					57.1	60	67.5	70	83.1	90
HVPA36HPA	208/230-1-60	28.6	40			31.0	45	36.3	45					57.1	60	67.5	70	83.1	90
HVPA42HPA	208/230-1-60	32.6	50			32.6	50							57.1	60	67.5	70	83.1	90
HVPA48HPA	208/230-1-60	36.6	50			36.6	50							58.6	60	69.0	70	84.6	90
HVPA60HPA	208/230-1-60	42.1	60			42.1	60							58.6	60	69.0	70	84.6	90
HVPA24HPC	208/230-3-60	16.4	20					23.0	25			32.1	35			41.1	45	50.1	60
HVPA30HPC	208/230-3-60	18.2	25					23.0	25			32.1	35			41.1	45	50.1	60
HVPA36HPC	208/230-3-60	20.8	25					23.0	30			32.1	35			41.1	45	50.1	60
HVPA42HPC	208/230-3-60	24.8	35					24.8	35			32.1	35			41.1	45	50.1	60
HVPA48HPC	208/230-3-60	26.4	35					26.4	35			33.6	35			42.6	45	51.6	60
HVPA60HPC	208/230-3-60	28.8	40					28.8	40			33.6	40			42.6	45	51.6	60
HVPA24HPD	460-3-60	8.4	15					11.5	15			16.0	20			20.5	25	25.0	25
HVPA30HPD	460-3-60	10.3	15					11.5	15			16.0	20			20.5	25	25.0	25
HVPA36HPD	460-3-60	11.2	15					11.5	15			16.0	20			20.5	25	25.0	25
HVPA42HPD	460-3-60	11.5	15					11.5	15			16.0	20			20.5	25	25.0	25
HVPA48HPD	460-3-60	12.4	15					12.4	15			16.8	20			21.3	25	25.8	30
HVPA60HPD	460-3-60	14.3	20					14.3	20			16.8	20			21.3	25	25.8	30

S-Circuit - Compressor and electric heat do NOT operate simultaneously.
¹MCA = Minimum Circuit Ampacity (Wiring Size Amps) ²MFS = Maximum Fuse or HACR Breaker Size ³SPPE = Single Point Power Entry
MCA & MFS are calculated at 230 volts on the 208-230v. (HPA & HPC) models. The 460 volt HPD models are calculated at 460 volts. This chart should only be used as a guideline for estimating conductor size and overcurrent protection. For the requirements of specific units, always refer to the data label on the unit.

Unit Load Amps (Heating) - HVPA Heat Pumps w/Single Stage Compressor & Ventilation Configuration: Manual Damper, up to 15% outside air ("N") Manual Damper, up to 450 cfm of outside air ("Y") Manual Damper, up to 450 cfm of outside air with pressure relief ("Z") Motorized 2-Position Damper, up to 450 cfm of outside air w/Pressure Relief ("B") Economizer, Outside Air ("C")

MODEL NUMBER	VOLTAGE PHASE HERTZ	CURRENT (AMPS)		LOAD OF RESISTIVE HEATING - ELEMENTS ONLY (AMPS)										TOTAL MAXIMUM HEATING AMPS										
		HP ¹	IBM ²	(1) ALL HEATING ELEMENTS ARE ON A SEPARATE CIRCUIT (2) SHADED VALUES (12 & 15 kW) UTILIZE TWO CIRCUITS										INCLUDES AMPS FROM MOTOR(S) THAT ARE LOCATED ON AN ELECTRICAL CIRCUIT THAT DOES NOT HAVE HEATERS										
				04 kW	05 kW	06 kW	08 kW	09 kW	10 kW	12 kW	15 kW	04 Kw	05 Kw	06 Kw	08 Kw	09 Kw	10 Kw	12 Kw	15 Kw					
HVPA24HPA	208-230/1/60	17.4	2.8	16.7	20.8	25.0	33.3				41.7					34.1	38.2	42.4	50.7			59.1		
HVPA30HPA	208-230/1/60	18.4	2.8	16.7	20.8	25.0	33.3				41.7	50.0	62.5	35.1	39.2	43.4	51.7					60.1	68.4	80.9
HVPA36HPA	208-230/1/60	22.2	2.8	16.7	20.8	25.0	33.3				41.7	50.0	62.5	38.9	43.0	47.2	55.5					63.9	72.2	84.7
HVPA42HPA	208-230/1/60	25.4	2.8		20.8						41.7	50.0	62.5		46.2							67.1	75.4	87.9
HVPA48HPA	208-230/1/60	28.9	4.3		20.8						41.7	50.0	62.5		49.7							70.6	78.9	91.4
HVPA60HPA	208-230/1/60	33.3	4.3		20.8						41.7	50.0	62.5		54.1							75.0	83.3	95.8
HVPA24HPC	208-230/3/60	12.3	2.8			14.4			21.7		28.9	36.1			26.7			34.0				41.2	48.4	
HVPA30HPC	208-230/3/60	13.9	2.8			14.4			21.7		28.9	36.1			28.3			35.6				42.8	50.0	
HVPA36HPC	208-230/3/60	17.5	2.8			14.4			21.7		28.9	36.1			31.9			39.2				46.4	53.6	
HVPA42HPC	208-230/3/60	19.2	2.8			14.4			21.7		28.9	36.1			33.6			40.9				48.1	55.3	
HVPA48HPC	208-230/3/60	20.8	4.3			14.4			21.7		28.9	36.1			35.2			42.5				49.7	56.9	
HVPA60HPC	208-230/3/60	22.7	4.3			14.4			21.7		28.9	36.1			37.1			44.4				51.6	58.8	
HVPA24HPD	460/3/60	6.3	1.4			7.2			10.8		14.4	18.0			13.5			17.1				20.7	24.3	
HVPA30HPD	460/3/60	7.9	1.4			7.2			10.8		14.4	18.0			15.1			18.7				22.3	25.9	
HVPA36HPD	460/3/60	8.6	1.4			7.2			10.8		14.4	18.0			15.8			19.4				23.0	26.6	
HVPA42HPD	460/3/60	8.9	1.4			7.2			10.8		14.4	18.0			16.1			19.7				23.3	26.9	
HVPA48HPD	460/3/60	9.8	2.2			7.2			10.8		14.4	18.0			17.0			20.6				24.2	27.8	
HVPA60HPD	460/3/60	11.3	2.2			7.2			10.8		14.4	18.0			18.5			22.1				25.7	29.3	

¹HP = Heat Pump Unit Amps (includes Indoor Motor amps) ²IBM = Indoor Blower Motor
Heating kW is rated at 240 volts on the 208-230v. (HPA & HPC) models. Derate heater output by 25% for operation at 208 volts. Heating kW is rated at 480 volts on the HPD models.
Total heating amps for single phase units with two circuits (#1 and #2) includes both circuits. Total heating and cooling amps includes all motors. Three phase models contain single phase motor loads.
Values shown are maximum phase loads. Loads are not equally balanced on each phase.

Unit Load Amps (Heating) - HVPA Heat Pumps with Single Stage Compressor and GreenWheel® ERV - Ventilation Configuration ("H")

MODEL NUMBER	VOLTAGE PHASE HERTZ	CURRENT (AMPS)			LOAD OF RESISTIVE HEATING - ELEMENTS ONLY (AMPS) <i>(1) ALL HEATING ELEMENTS ARE ON A SEPARATE CIRCUIT (2) SHADED VALUES (12 & 15 kW) UTILIZE TWO CIRCUITS</i>								TOTAL MAXIMUM HEATING AMPS <i>INCLUDES AMPS FROM MOTOR(S) THAT ARE LOCATED ON AN ELECTRICAL CIRCUIT THAT DOES NOT HAVE HEATERS</i>							
		HP ¹	IBM ²	H ³	04 kW	05 kW	06 kW	08 kW	09 kW	10 kW	12 kW	15 kW	04 Kw	05 Kw	06 Kw	08 Kw	09 Kw	10 Kw	12 Kw	15 Kw
HVPA24HPA	208-230/1/60	19.6	2.8	2.2	16.7	20.8	25.0	33.3		41.7			19.5	40.4	44.6	52.9		61.3		
HVPA30HPA	208-230/1/60	20.6	2.8	2.2	16.7	20.8	25.0	33.3		41.7	50.0	62.5	19.5	41.4	45.6	53.9		62.3	70.6	83.1
HVPA36HPA	208-230/1/60	24.4	2.8	2.2	16.7	20.8	25.0	33.3		41.7	50.0	62.5	19.5	45.2	49.4	57.7		66.1	74.4	86.9
HVPA42HPA	208-230/1/60	27.6	2.8	2.2		20.8				41.7	50.0	62.5		48.4				69.3	77.6	90.1
HVPA48HPA	208-230/1/60	31.1	4.3	2.2		20.8				41.7	50.0	62.5		51.9				72.8	81.1	93.6
HVPA60HPA	208-230/1/60	35.5	4.3	2.2		20.8				41.7	50.0	62.5		56.3				77.2	85.5	98.0
HVPA24HPC	208-230/3/60	14.5	2.8	2.2			14.4		21.7		28.9	36.1			28.9		36.2		43.4	50.6
HVPA30HPC	208-230/3/60	16.1	2.8	2.2			14.4		21.7		28.9	36.1			30.5		37.8		45.0	52.2
HVPA36HPC	208-230/3/60	19.7	2.8	2.2			14.4		21.7		28.9	36.1			34.1		41.4		48.6	55.8
HVPA42HPC	208-230/3/60	21.4	2.8	2.2			14.4		21.7		28.9	36.1			35.8		43.1		50.3	57.5
HVPA48HPC	208-230/3/60	23.0	4.3	2.2			14.4		21.7		28.9	36.1			37.4		44.7		51.9	59.1
HVPA60HPC	208-230/3/60	24.9	4.3	2.2			14.4		21.7		28.9	36.1			39.3		46.6		53.8	61.0
HVPA24HPD	460/3/60	7.4	1.4	1.1			7.2		10.8		14.4	18.0			14.6		18.2		21.8	25.4
HVPA30HPD	460/3/60	9.0	1.4	1.1			7.2		10.8		14.4	18.0			16.2		19.8		23.4	27.0
HVPA36HPD	460/3/60	9.7	1.4	1.1			7.2		10.8		14.4	18.0			16.9		20.5		24.1	27.7
HVPA42HPD	460/3/60	10.0	1.4	1.1			7.2		10.8		14.4	18.0			17.2		20.8		24.4	28.0
HVPA48HPD	460/3/60	10.9	2.2	1.1			7.2		10.8		14.4	18.0			18.1		21.7		25.3	28.9
HVPA60HPD	460/3/60	12.4	2.2	1.1			7.2		10.8		14.4	18.0			19.6		23.2		26.8	30.4

¹HP = Heat Pump Unit Amps (includes Indoor Motor amps) ²IBM = Indoor Blower Motor ³H = GreenWheel ERV
 Heating kW is rated at 240 volts on the 208-230v. (HPA & HPC) models. Derate heater output by 25% for operation at 208 volts. Heating kW is rated at 480 volts on the HPD models.
 Total heating amps for single phase units with two circuits (#1 and #2) includes both circuits. Total heating and cooling amps includes all motors. Three phase models contain single phase motor loads. Values shown are maximum phase loads. Loads are not equally balanced on each phase.

Certified Efficiency and Capacity Ratings at ANSI/ARI Standard 390 - for HVPSA Heat Pumps with 2-Stage Compressor

Model Number	HVPSA24HP			HVPSA30HP			HVPSA36HP1			HVPSA42HP1			HVPSA49HP1			HVPSA60		
	HPA	HPC	HPD	HPA	HPC	HPD	HPA	HPC	HPD	HPA	HPC	HPD	HPA	HPC	HPD	HPA	HPC	HPD
Cooling BTUH¹ - 2nd Stage	23,000			29,000			35,000			39,000			47,000			57,000		
EER² - 2nd Stage	10.50			10.50			10.00			10.20			11.00			10.90		
Integrated Part Load Value³	14.0			14.0			14.00			13.60			15.0			14.80		
High Temperature Heating⁴	22,000			26,000			31,400			37,600			39,000			50,500		
High Temperature COP⁵	3.00			3.00			3.20			3.15			3.00			3.00		
Rated Air Flow (CFM⁶)	800			1,000			1,200			1,300			1,750			1,750		

¹Cooling is rated at 95°F (35°C) outdoor and 80°F DB/67°F WB (26.5°C DB/19.5°C WB) return air.

²EER = Energy Efficiency Ratio

³Integrated Part Load Value is an integrated efficiency measure from 1st and 2nd stage capacity modulation.

⁴High Temperature Heating & COP is rated at 47°F DB/43°WB (8.3°C DB/6.1°C WB) outdoor and 70°F (21.1°C) return air.

⁵COP = Coefficient of Performance

⁶CFM = Cubic Feet per Minute

Ratings are with no outside air. Performance will be affected by altitude. Ratings are at 230 volts for 208/230 volt units ("A" & "C" models) and 460 volts for "D" models.

Operation of units at a different voltage from that of the rating point will affect performance and air flow.

Sensible Total Heat Ratio @ 95°F (35°C) Outside Air DB - HVPSA Heat Pumps - Stage 2

Model Number	HVPSA24HP			HVPSA30HP			HVPSA36HP1			HVPSA42HP1			HVPSA49HP1			HVPSA60		
	HPA	HPC	HPD	HPA	HPC	HPD	HPA	HPC	HPD	HPA	HPC	HPD	HPA	HPC	HPD	HPA	HPC	HPD
Total Capacity	23,000			29,000			35,000			39,000			47,000			57,000		
Sensible Heat Ratio	0.75			0.78			0.72			0.70			0.74			0.71		
Sensible Capacity	17,315			22,525			25,485			27,460			34,710			40,605		
Rated Air Flow (CFM)	800			1,000			1,200			1,300			1,750			1,750		

¹CFM=Cubic Feet per Minute

Sensible Heat Ratios based upon ANSI/AHRI std. 390 outdoor conditions of 95°F (35°C) outdoor and 80°F DB/67°F WB (26.5°C DB/19.5°C WB) return air.

Cooling Performance (BTUH) at Various Outdoor Temperatures - HVPSA Heat Pumps - Stage 2

Model Number	Outdoor Temperature								
	75°F/24°C	80°F/26.5°C	85°F/29°C	90°F/32°C	95°F/35°C	100°F/38°C	105°F/40.5°C	110°F/43.3°C	115°F/46°C
HVPSA24HP	26,680	25,760	24,840	23,920	23,000	22,080	21,160	20,240	19,780
HVPSA30HP	33,640	32,480	31,320	30,160	29,000	27,840	26,680	25,520	24,940
HVPSA36HP1	40,600	39,200	37,800	36,400	35,000	33,600	32,200	30,800	30,100
HVPSA42HP1	45,240	43,680	42,120	40,560	39,000	37,440	35,880	34,320	33,540
HVPSA49HP1	54,520	52,640	50,760	48,880	47,000	45,120	43,240	41,360	40,420
HVPSA60HP	66,120	63,840	61,560	59,280	57,000	54,720	52,440	50,160	49,020

Based upon ANSI/AHRI std. 390 return air conditions of 80°F DB/67°F WB (26.5°C DB/19.5°C WB). Return air at rated air flow.

Heating Performance (BTUH) at Various Outdoor Temperatures - HVPSA Heat Pumps with 2-Stage Compressor

Model Number	Outdoor Temperature								
	10°F/-12.2°C	17°F/-8.3°C	20°F/-6.7°C	30°F/-1.1°C	40°F/4.4°C	47°F/8.3°C	50°F/10°C	60°F/15.6°C	70°F/21.1°C
HVPSA24HP	10,285	12,100	13,090	16,555	19,525	22,000	22,660	23,650	24,750
HVPSA30HP	12,155	14,300	15,470	19,565	23,075	26,000	26,780	27,950	29,250
HVPSA36HP1	14,620	17,200	18,620	23,590	27,850	31,400	32,342	33,755	35,325
HVPSA42HP1	17,680	20,800	22,420	28,090	32,950	37,000	38,110	39,775	41,625
HVPSA49HP1	18,700	22,000	23,700	29,650	34,750	39,000	40,170	41,925	43,875
HVPSA60HP	25,500	30,000	32,050	39,225	45,375	50,500	52,015	54,288	56,813

Based upon ANSI/AHRI std. 390 return air conditions of 70°F DB (21.1°C DB). Return air at rated air flow.

**Electrical Characteristics - HVPSA Heat Pumps - 2-Stage Compressor
Manual Damper, up to 15% outside air ("N")
Manual Damper, up to 450 cfm of outside air ("Y")
Manual Damper, up to 450 cfm of outside air with pressure relief ("Z")
Motorized 2-Position Damper, up to 450 cfm of outside air w/Pressure Relief ("B")
Economizer, Outside air with Pressure Relief ("C")
GreenWheel® Energy Recovery Ventilator ("H")
Compressor, Fan, Ventilation & Blower Motors -**

Model Number	COMPRESSOR			OTHER MOTORS	OUTDOOR FAN MOTOR			INDOOR BLOWER MOTOR (ECM)			VENTILATION GREENWHEEL® ERV		
	VOLTS-HZ-PH	RLA ¹	LRA ²	VOLTS-HZ-PH	RPM ³	FLA ⁴	HP ⁵	RPM ³	FLA ⁴	HP ⁵	AMPS		
											OAM ⁶	EXM ⁷	WD ⁸
HVPSA24HPA	208/230-60-1	11.6	58.3	208/230-60-1	825	1.8	1/4	1500	2.8	1/3	1.0	1.0	0.2
HVPSA30HPA	208/230-60-1	13.1	73.0	208/230-60-1	825	2.8	1/3	1500	2.8	1/2	1.0	1.0	0.2
HVPSA36HP1A	208/230-60-1	15.2	83.0	208/230-60-1	825	2.8	1/3	1500	2.8	1/2	1.0	1.0	0.2
HVPSA42HP1A	208/230-60-1	17.9	96.0	208/230-60-1	825	2.8	1/3	1500	2.8	1/2	1.0	1.0	0.2
HVPSA49HP1A	208/230-60-1	21.1	104.0	208/230-60-1	825	2.8	1/2	1500	4.3	3/4	1.0	1.0	0.2
HVPSA60HPA	208/230-60-1	27.1	152.9	208/230-60-1	825	2.8	1/2	1500	4.3	3/4	1.0	1.0	0.2
HVPSA24HPC	208/230-60-3	6.5	55.4	208/230-60-1	825	1.8	1/4	1500	2.8	1/3	1.0	1.0	0.2
HVPSA30HPC	208/230-60-3	8.6	58.0	208/230-60-1	825	2.8	1/3	1500	2.8	1/2	1.0	1.0	0.2
HVPSA36HP1C	208/230-60-3	11.6	73.0	208/230-60-1	825	2.8	1/3	1500	2.8	1/2	1.0	1.0	0.2
HVPSA42HP1C	208/230-60-3	14.1	88.0	208/230-60-1	825	2.8	1/3	1500	2.8	1/2	1.0	1.0	0.2
HVPSA49HP1C	208/230-60-3	14.0	83.1	208/230-60-1	825	2.8	1/2	1500	4.3	3/4	1.0	1.0	0.2
HVPSA60HPC	208/230-60-3	16.5	110.0	208/230-60-1	825	2.8	1/2	1500	4.3	3/4	1.0	1.0	0.2
HVPSA24HPD	460-60-3	3.5	28.0	208/230-60-1	825	1.8	1/4	1500	2.8	1/3	1.0	1.0	0.2
HVPSA30HPD	460-60-3	4.3	28.0	208/230-60-1	825	2.8	1/3	1500	2.8	1/2	1.0	1.0	0.2
HVPSA36HP1D	460-60-3	5.7	38.0	208/230-60-1	825	2.8	1/3	1500	2.8	1/2	1.0	1.0	0.2
HVPSA42HP1D	460-60-3	6.2	44.0	208/230-60-1	825	2.8	1/3	1500	2.8	1/2	1.0	1.0	0.2
HVPSA49HP1D	460-60-3	6.4	41.0	208/230-60-1	825	2.8	1/2	1500	4.3	3/4	1.0	1.0	0.2
HVPSA60HPD	460-60-3	7.2	52.0	208/230-60-1	825	2.8	1/2	1500	4.3	3/4	1.0	1.0	0.2

¹RLA = Rated Load Amps ²LRA = Locked Rotor Amps ³RPM = Revolutions per Minute ⁴FLA = Full Load Amps
⁵HP = Horsepower ⁶OAM = Outside Air Mover ⁷EXM = Exhaust Air Mover ⁸WD = Wheel Drive Motor
The 460 volt units have a step down transformer for the 230 volt motors.

**Electrical Characteristics - HVPSA Heat Pumps - 2-Stage Compressor
GreenCube® Energy Recovery Ventilator ("Q")
Compressor, Fan, Ventilation & Blower Motors-**

Model Number	COMPRESSOR			OTHER MOTORS	OUTDOOR FAN MOTOR			INDOOR BLOWER MOTOR (ECM)			VENTILATION GREENCUBE® ERV	
	VOLTS-HZ-PH	RLA ¹	LRA ²	VOLTS-HZ-PH	RPM ³	FLA ⁴	HP ⁵	RPM ³	FLA ⁴	HP ⁵	AMPS	
											OAM ⁶	EXM ⁷
HVPSA36HP1A	208/230-60-1	15.2	83.0	208/230-60-1	825	2.0	1/4	1500	2.8	1/2	0.7	0.4
HVPSA42HP1A	208/230-60-1	17.9	96.0	208/230-60-1	825	2.0	1/4	1500	2.8	1/2	0.7	0.4
HVPSA49HP1A	208/230-60-1	21.1	104.0	208/230-60-1	825	2.9	1/2	1500	4.3	3/4	0.7	0.4
HVPSA60HPA	208/230-60-1	27.1	152.9	208/230-60-1	825	2.9	1/2	1500	4.3	3/4	0.7	0.4
HVPSA36HP1C	208/230-60-3	11.6	73.0	208/230-60-1	825	2.0	1/4	1500	2.8	1/2	0.7	0.4
HVPSA42HP1C	208/230-60-3	14.1	88.0	208/230-60-1	825	2.0	1/4	1500	2.8	1/2	0.7	0.4
HVPSA49HP1C	208/230-60-3	14.0	83.1	208/230-60-1	825	2.9	1/2	1500	4.3	3/4	0.7	0.4
HVPSA60HPC	208/230-60-3	16.5	110.0	208/230-60-1	825	2.9	1/2	1500	4.3	3/4	0.7	0.4
HVPSA36HP1D	460-60-3	5.7	38.0	208/230-60-1	825	2.0	1/4	1500	2.8	1/2	0.7	0.4
HVPSA42HP1D	460-60-3	6.2	44.0	208/230-60-1	825	2.0	1/4	1500	2.8	1/2	0.7	0.4
HVPSA49HP1D	460-60-3	6.4	41.0	208/230-60-1	825	2.9	1/2	1500	4.3	3/4	0.7	0.4
HVPSA60HPD	460-60-3	7.2	52.0	208/230-60-1	825	2.9	1/2	1500	4.3	3/4	0.7	0.4

¹RLA = Rated Load Amps ²LRA = Locked Rotor Amps ³RPM = Revolutions per Minute ⁴FLA = Full Load Amps
⁵HP = Horsepower ⁶OAM = Outside Air Mover ⁷EXM = Exhaust Air Mover
The 460 volt units have a step down transformer for the 230 volt motors.

Summary Electrical Ratings (Wire and HACR Circuit Breaker Sizing) - HVPSA Heat Pumps w/2-Stage Compressor and Ventilation Configurations:
Manual Damper, up to 15% outside air ("N")
Manual Damper, up to 450 cfm of outside air ("Y")
Manual Damper, up to 450 cfm of outside air with pressure relief ("Z")
Motorized, 2-Position Damper, up to 450 CFM of Outside Air w/Pressure Relief ("B")
Economizer, Outside Air ("C")

ELECTRIC HEAT		000 = None		040 = 4 kw		050 = 5 kw		060 = 6 kw		080 = 8 kw		090 = 9 kw		100 = 10 kw		120 = 12 kw		150 = 15 kw	
		SPPE ³		SPPE ³		SPPE ³		SPPE ³		SPPE ³		SPPE ³		SPPE ³		SPPE ³		SPPE ³	
BASIC MODEL	VOLTS-HZ-PH	MCA ¹	MFS ²	MCA ¹	MFS ²	MCA ¹	MFS ²	MCA ¹	MFS ²	MCA ¹	MFS ²	MCA ¹	MFS ²	MCA ¹	MFS ²	MCA ¹	MFS ²	MCA ¹	MFS ²
HVPSA24HPA	208/230-1-60	19.1	30	40.0	40	45.1	50	50.4	60	60.7	70			71.2	80				
HVPSA30HPA	208/230-1-60	22.0	35			48.0	50	53.3	60	63.6	70			74.1	80	84.5	90	100.1	110
HVPSA36HP1A	208/230-1-60	24.6	35			50.6	60	55.9	60	66.2	70				80	87.1	90	102.7	110
HVPSA42HP1A	208/230-1-60	28.0	45			54.0	60							80.1	90	90.5	100	106.1	110
HVPSA49HP1A	208/230-1-60	33.5	50			59.5	60							85.6	90	96.0	100	111.6	120
HVPSA60HPA	208/230-1-60	41.0	60			67.0	70							93.1	100	103.5	110	119.1	120
HVPSA24HPC	208/230-3-60	12.7	15					30.7	35			40.0	40						
HVPSA30HPC	208/230-3-60	16.4	20					34.4	35			43.7	45			52.5	60	61.5	70
HVPSA36HP1C	208/230-3-60	20.1	30					38.1	40			47.4	50			56.2	60	65.2	70
HVPSA42HP1C	208/230-3-60	23.2	35					41.2	45			50.5	60			59.3	60	68.3	70
HVPSA49HP1C	208/230-3-60	24.6	35					42.6	45			51.9	60			60.7	70	69.7	70
HVPSA60HPC	208/230-3-60	27.7	40					45.7	50			55.0	60			63.8	70	72.8	80
HVPSA24HPD	460-3-60	6.7	15					15.7	20			20.2	25			24.7	25	28.9	30
HVPSA30HPD	460-3-60	8.2	15					17.2	20			21.7	25			26.2	30	30.7	35
HVPSA36HP1D	460-3-60	9.9	15					18.9	20			23.4	25			27.9	30	32.4	35
HVPSA42HP1D	460-3-60	10.6	15					19.6	20			24.1	25			28.6	30	33.1	35
HVPSA49HP1D	460-3-60	11.6	15					20.6	25			25.1	30			29.6	30	34.1	35
HVPSA60HPD	460-3-60	12.6	15					21.6	25			26.1	30			30.6	35	35.1	40

¹MCA = Minimum Circuit Ampacity (Wiring Size Amps) ²MFS = Maximum Fuse or HACR Breaker Size ³SPPE = Single Point Power Entry
MCA & MFS are calculated at 230 volts on the 208-230v. (HPA & HPC) models. The 460 volt HPD models are calculated at 460 volts. This chart should only be used as a guideline for estimating conductor size and overcurrent protection. For the requirements of specific units, always refer to the data label on the unit.

Summary Electrical Ratings (Wire and HACR Circuit Breaker Sizing) - HVPSA Heat Pumps with Two Stage Compressor and "S" Circuit and Ventilation Configurations:
Manual Damper, up to 15% outside air ("N")
Manual Damper, up to 450 cfm of outside air ("Y")
Manual Damper, up to 450 cfm of outside air with pressure relief ("Z")
Motorized, 2-Position Damper, up to 450 CFM of Outside Air w/Pressure Relief ("B")
Economizer, Outside Air ("C")

ELECTRIC HEAT		000 = None		040 = 4 kw		050 = 5 kw		060 = 6 kw		080 = 8 kw		090 = 9 kw		100 = 10 kw		120 = 12 kw		150 = 15 kw	
		SPPE ³		SPPE ³		SPPE ³		SPPE ³		SPPE ³		SPPE ³		SPPE ³		SPPE ³		SPPE ³	
BASIC MODEL	VOLTS-HZ-PH	MCA ¹	MFS ²	MCA ¹	MFS ²	MCA ¹	MFS ²	MCA ¹	MFS ²	MCA ¹	MFS ²	MCA ¹	MFS ²	MCA ¹	MFS ²	MCA ¹	MFS ²	MCA ¹	MFS ²
HVPSA24HPA	208/230-1-60	19.1	30	23.7	30	28.8	30	34.1	35					54.9	60				
HVPSA30HPA	208/230-1-60	22.0	35			28.8	35	34.1	35					54.9	60	65.3	70	80.9	90
HVPSA36HP1A	208/230-1-60	24.6	35			28.8	35	34.1	35					54.9	60	65.3	70	80.9	90
HVPSA42HP1A	208/230-1-60	28.0	45			28.8	45							54.9	60	65.3	70	80.9	90
HVPSA49HP1A	208/230-1-60	33.5	50			33.5	50							56.4	60	66.8	70	82.4	90
HVPSA60HPA	208/230-1-60	41.0	60			41.0	60							56.4	60	66.8	70	82.4	90
HVPSA24HPC	208/230-3-60	12.7	15					20.8	25			29.9	30			38.9	40	47.9	50
HVPSA30HPC	208/230-3-60	16.4	20					20.8	25			29.9	30			38.9	40	47.9	50
HVPSA36HP1C	208/230-3-60	20.1	30					20.8	30			29.9	30			38.9	40	47.9	50
HVPSA42HP1C	208/230-3-60	23.2	35					23.2	35			29.9	35			38.9	40	47.9	50
HVPSA49HP1C	208/230-3-60	24.6	35					24.6	35			31.4	35			40.4	45	49.4	50
HVPSA60HPC	208/230-3-60	27.7	40					27.7	40			31.4	40			40.4	45	49.4	50
HVPSA24HPD	460-3-60	6.7	15					10.4	15			14.9	15			19.4	20	23.9	25
HVPSA30HPD	460-3-60	8.2	15					10.4	15			14.9	15			19.4	20	23.9	25
HVPSA36HP1D	460-3-60	9.9	15					10.4	15			14.9	15			19.4	20	23.9	25
HVPSA42HP1D	460-3-60	10.6	15					10.6	15			14.9	15			19.4	20	23.9	25
HVPSA49HP1D	460-3-60	11.6	15					11.6	15			15.7	20			20.2	25	24.7	25
HVPSA60HPD	460-3-60	12.6	15					12.6	15			15.7	20			20.2	25	24.7	25

S-Circuit - Compressor and electric heat do NOT operate simultaneously.
¹MCA = Minimum Circuit Ampacity (Wiring Size Amps) ²MFS = Maximum Fuse or HACR Breaker Size ³SPPE = Single Point Power Entry
MCA & MFS are calculated at 230 volts on the 208-230v. (HPA & HPC) models. The 460 volt HPD models are calculated at 460 volts. This chart should only be used as a guideline for estimating conductor size and overcurrent protection. For the requirements of specific units, always refer to the data label on the unit.

Summary Electrical Ratings (Wire and HACR Circuit Breaker Sizing) - HVPSA Heat Pumps with 2-Stage Compressor and GreenWheel® Energy Recovery Ventilator - Ventilation Configuration ("H")

ELECTRIC HEAT		000 = None		040 = 4 kw		050 = 5 kw		060 = 6 kw		080 = 8 kw		090 = 9 kw		100 = 10 kw		120 = 12 kw		150 = 15 kw	
		SPPE ³		SPPE ³		SPPE ³		SPPE ³		SPPE ³		SPPE ³		SPPE ³		SPPE ³		SPPE ³	
BASIC MODEL	VOLTS-HZ-PH	MCA ¹	MFS ²	MCA ¹	MFS ²	MCA ¹	MFS ²	MCA ¹	MFS ²	MCA ¹	MFS ²	MCA ¹	MFS ²	MCA ¹	MFS ²	MCA ¹	MFS ²	MCA ¹	MFS ²
HVPSA24HPA	208/230-1-60	21.3	30	42.2	45	47.3	50	52.6	60	62.9	70			73.4	80				
HVPSA30HPA	208/230-1-60	24.2	35			50.2	60	55.5	60	65.8	70			76.3	80	86.7	90	102.3	110
HVPSA36HP1A	208/230-1-60	26.8	40			52.8	60	58.1	60	68.4	70			78.9	80	89.3	90	104.9	110
HVPSA42HP1A	208/230-1-60	30.2	45			56.2	60							82.3	90	92.7	100	108.3	120
HVPSA49HP1A	208/230-1-60	35.7	50			61.7	70							87.8	90	98.2	100	113.8	120
HVPSA60HPA	208/230-1-60	43.2	60			69.2	70							95.3	100	105.7	110	121.3	130
HVPSA24HPC	208/230-3-60	14.9	20					32.9	35			42.0	45						
HVPSA30HPC	208/230-3-60	18.6	25					36.6	40			45.7	50			54.7	60	63.7	70
HVPSA36HP1C	208/230-3-60	22.3	30					40.3	45			49.4	50			58.4	60	67.4	70
HVPSA42HP1C	208/230-3-60	25.4	35					43.4	45			52.5	60			61.5	70	70.5	80
HVPSA49HP1C	208/230-3-60	26.8	40					44.8	45			53.9	60			62.9	70	71.9	80
HVPSA60HPC	208/230-3-60	29.9	45					47.9	50			57.0	60			66.0	70	75.0	80
HVPSA24HPD	460-3-60	7.8	15					16.8	20			21.3	25			25.8	30	30.3	35
HVPSA30HPD	460-3-60	9.3	15					18.3	20			22.8	25			27.3	30	31.8	35
HVPSA36HP1D	460-3-60	11.0	15					20.0	20			24.5	25			29.0	30	33.5	35
HVPSA42HP1D	460-3-60	11.7	15					20.7	25			25.2	30			29.7	30	34.2	35
HVPSA49HP1D	460-3-60	12.7	15					21.7	25			26.2	30			30.7	35	35.2	40
HVPSA60HPD	460-3-60	13.7	20					22.7	25			27.2	30			31.7	35	36.2	40

¹MCA = Minimum Circuit Ampacity (Wiring Size Amps) ²MFS = Maximum Fuse or HACR Breaker Size ³SPPE = Single Point Power Entry
MCA & MFS are calculated at 230 volts on the 208-230v. (HPA & HPC) models. The 460 volt HPD models are calculated at 460 volts. This chart should only be used as a guideline for estimating conductor size and overcurrent protection. For the requirements of specific units, always refer to the data label on the unit.

Summary Electrical Ratings (Wire and HACR Circuit Breaker Sizing) - HVPSA Heat Pumps with Two Stage Compressor and "S" Circuit GreenWheel® Energy Recovery Ventilator - Ventilation Configuration ("H")

ELECTRIC HEAT		000 = None		040 = 4 kw		050 = 5 kw		060 = 6 kw		080 = 8 kw		090 = 9 kw		100 = 10 kw		120 = 12 kw		150 = 15 kw	
		SPPE ³		SPPE ³		SPPE ³		SPPE ³		SPPE ³		SPPE ³		SPPE ³		SPPE ³		SPPE ³	
BASIC MODEL	VOLTS-HZ-PH	MCA ¹	MFS ²	MCA ¹	MFS ²	MCA ¹	MFS ²	MCA ¹	MFS ²	MCA ¹	MFS ²	MCA ¹	MFS ²	MCA ¹	MFS ²	MCA ¹	MFS ²	MCA ¹	MFS ²
HVPSA24HPA	208/230-1-60	21.3	30	25.9	30	31.0	35	36.3	40					57.1	60				
HVPSA30HPA	208/230-1-60	24.2	35			31.0	35	36.3	40					57.1	60	67.5	70	83.1	90
HVPSA36HP1A	208/230-1-60	26.8	40			31.0	40	36.3	40					57.1	60	67.5	70	83.1	90
HVPSA42HP1A	208/230-1-60	30.2	45			31.0	45							57.1	60	67.5	70	83.1	90
HVPSA49HP1A	208/230-1-60	35.7	50			35.7	50							58.6	60	69.0	70	84.6	90
HVPSA60HPA	208/230-1-60	43.2	60			43.2	60							58.6	60	69.0	70	84.6	90
HVPSA24HPC	208/230-3-60	14.9	20					23.0	25			32.1	35			41.1	45	50.1	60
HVPSA30HPC	208/230-3-60	18.6	25					23.0	25			32.1	35			41.1	45	50.1	60
HVPSA36HP1C	208/230-3-60	22.3	30					23.0	30			32.1	35			41.1	45	50.1	60
HVPSA42HP1C	208/230-3-60	25.4	35					25.4	35			32.1	35			41.1	45	50.1	60
HVPSA49HP1C	208/230-3-60	26.8	40					26.8	40			33.6	40			42.6	45	51.6	60
HVPSA60HPC	208/230-3-60	29.9	45					29.9	45			33.6	45			42.6	45	51.6	60
HVPSA24HPD	460-3-60	7.8	15					11.5	15			16.0	20			20.5	25	25.0	25
HVPSA30HPD	460-3-60	9.3	15					11.5	15			16.0	20			20.5	25	25.0	25
HVPSA36HP1D	460-3-60	11.0	15					11.5	15			16.0	20			20.5	25	25.0	25
HVPSA42HP1D	460-3-60	11.7	15					11.5	15			16.0	20			20.5	25	25.0	25
HVPSA49HP1D	460-3-60	12.7	15					12.7	15			16.8	20			21.3	25	25.8	30
HVPSA60HPD	460-3-60	13.7	20					13.7	20			16.8	20			21.3	25	25.8	30

S-Circuit - Compressor and electric heat do NOT operate simultaneously.
¹MCA = Minimum Circuit Ampacity (Wiring Size Amps) ²MFS = Maximum Fuse or HACR Breaker Size ³SPPE = Single Point Power Entry
MCA & MFS are calculated at 230 volts on the 208-230v. (HPA & HPC) models. The 460 volt HPD models are calculated at 460 volts. This chart should only be used as a guideline for estimating conductor size and overcurrent protection. For the requirements of specific units, always refer to the data label on the unit.

Summary Electrical Ratings (Wire and HACR Circuit Breaker Sizing) - HVPSA Heat Pump with 2- Stage Compressor & Ventilation Configuration: GreenCube® ERV - Ventilation Configuration ("Q")

ELECTRIC HEAT		000 = None		040 = 4 kw		050 = 5 kw		060 = 6 kw		080 = 8 kw		090 = 9 kw		100 = 10 kw		120 = 12 kw		150 = 15 kw	
		SPPE ³		SPPE ³		SPPE ³		SPPE ³		SPPE ³		SPPE ³		SPPE ³		SPPE ³		SPPE ³	
BASIC MODEL	VOLTS-HZ-PH	MCA ¹	MFS ²	MCA ¹	MFS ²	MCA ¹	MFS ²	MCA ¹	MFS ²	MCA ¹	MFS ²	MCA ¹	MFS ²	MCA ¹	MFS ²	MCA ¹	MFS ²	MCA ¹	MFS ²
HVPSA36HP1A	208/230-1-60	24.9	40			50.9	60	56.2	60	66.5	70			77.0	80	87.4	90	103.0	110
HVPSA42HP1A	208/230-1-60	28.3	45			54.3	60							80.4	90	90.8	100	106.4	110
HVPSA49HP1A	208/230-1-60	34.7	50			60.7	70							86.8	90	97.2	100	112.8	120
HVPSA60HPA	208/230-1-60	42.2	60			68.2	70							94.3	100	104.7	110	120.3	130
HVPSA36HP1C	208/230-3-60	20.4	30					38.4	45			47.5	50			56.5	60	65.5	70
HVPSA42HP1C	208/230-3-60	23.5	35					41.5	45			50.6	60			59.6	60	68.6	70
HVPSA49HP1C	208/230-3-60	25.8	35					43.8	45			52.9	60			61.9	70	70.9	80
HVPSA60HPC	208/230-3-60	28.9	45					46.9	50			56.0	60			65.0	70	74.0	80
HVPSA36HP1D	460-3-60	10.1	15					19.1	20			23.6	25			28.1	30	32.6	35
HVPSA42HP1D	460-3-60	10.7	15					19.7	20			24.2	30			28.7	30	33.2	35
HVPSA49HP1D	460-3-60	12.2	15					21.2	25			25.7	30			30.2	35	34.7	35
HVPSA60HPD	460-3-60	13.2	20					22.2	25			26.7	30			31.2	35	35.7	40

¹MCA = Minimum Circuit Ampacity (Wiring Size Amps) ²MFS = Maximum Fuse or HACR Breaker Size ³SPPE = Single Point Power Entry
MCA & MFS are calculated at 230 volts on the 208-230v. (HPA & HPC) models. The 460 volt HPD models are calculated at 460 volts. This chart should only be used as a guideline for estimating conductor size and overcurrent protection. For the requirements of specific units, always refer to the data label on the unit.

Summary Electrical Ratings (Wire and HACR Circuit Breaker Sizing) - HVPSA Heat Pumps with 2-Stage Compressor and "S" Circuit and Ventilation Configurations: GreenCube® ERV - Ventilation Configuration ("Q")

ELECTRIC HEAT		000 = None		040 = 4 kw		050 = 5 kw		060 = 6 kw		080 = 8 kw		090 = 9 kw		100 = 10 kw		120 = 12 kw		150 = 15 kw	
		SPPE ³		SPPE ³		SPPE ³		SPPE ³		SPPE ³		SPPE ³		SPPE ³		SPPE ³		SPPE ³	
BASIC MODEL	VOLTS-HZ-PH	MCA ¹	MFS ²	MCA ¹	MFS ²	MCA ¹	MFS ²	MCA ¹	MFS ²	MCA ¹	MFS ²	MCA ¹	MFS ²	MCA ¹	MFS ²	MCA ¹	MFS ²	MCA ¹	MFS ²
HVPSA36HP1A	208/230-1-60	24.9	40			29.9	40	35.2	40					56.0	60	66.4	70	82.0	90
HVPSA42HP1A	208/230-1-60	28.3	45			29.9	45							56.0	60	66.4	70	82.0	90
HVPSA49HP1A	208/230-1-60	34.7	50			34.7	50							57.5	60	67.9	70	83.5	90
HVPSA60HPA	208/230-1-60	42.2	60			42.2	60							57.5	60	67.9	70	83.5	90
HVPSA36HP1C	208/230-3-60	20.4	30					21.9	30			31.0	35			40.0	40	49.0	50
HVPSA42HP1C	208/230-3-60	23.5	35					23.5	35			31.0	35			40.0	40	49.0	50
HVPSA49HP1C	208/230-3-60	25.8	35					25.8	35			32.5	35			41.5	45	50.5	60
HVPSA60HPC	208/230-3-60	28.9	45					28.9	45			32.5	45			41.5	45	50.5	60
HVPSA36HP1D	460-3-60	10.1	15					11.0	15			15.5	20			20.0	20	24.5	25
HVPSA42HP1D	460-3-60	10.7	15					11.0	15			15.5	20			20.0	20	24.5	25
HVPSA49HP1D	460-3-60	12.2	15					12.2	15			16.2	20			20.7	25	25.2	30
HVPSA60HPD	460-3-60	13.2	20					13.2	20			16.2	20			20.7	25	25.2	30

S-Circuit - Compressor and electric heat do NOT operate simultaneously.
¹MCA = Minimum Circuit Ampacity (Wiring Size Amps) ²MFS = Maximum Fuse or HACR Breaker Size ³SPPE = Single Point Power Entry
MCA & MFS are calculated at 230 volts on the 208-230v. (HPA & HPC) models. The 460 volt HPD models are calculated at 460 volts. This chart should only be used as a guideline for estimating conductor size and overcurrent protection. For the requirements of specific units, always refer to the data label on the unit.

Unit Load Amps (Heating) - HVPSA Heat Pumps w/2-Stage Compressor & Ventilation Configuration: Manual Damper, up to 15% outside air ("N") Manual Damper, up to 450 cfm of outside air ("Y") Manual Damper, up to 450 cfm of outside air with pressure relief ("Z") Motorized 2-Position Damper, up to 450 cfm of outside air w/Pressure Relief ("B") Economizer, Outside Air ("C")

MODEL NUMBER	VOLTAGE PHASE HERTZ	CURRENT (AMPS)		LOAD OF RESISTIVE HEATING - ELEMENTS ONLY (AMPS) (1) ALL HEATING ELEMENTS ARE ON A SEPARATE CIRCUIT (2) SHADED VALUES (12 & 15 kW) UTILIZE TWO CIRCUITS								TOTAL MAXIMUM HEATING AMPS INCLUDES AMPS FROM MOTOR(S) THAT ARE LOCATED ON AN ELECTRICAL CIRCUIT THAT DOES NOT HAVE HEATERS							
		HP ¹	IBM ²	04 kW	05 kW	06 kW	08 kW	09 kW	10 kW	12 kW	15 kW	04 Kw	05 Kw	06 Kw	08 Kw	09 Kw	10 Kw	12 Kw	15 Kw
HVPSA24HPA	208-230/1/60	16.2	2.8	16.7	20.8	25.0	33.3		41.7			32.9	37.0	41.2	49.5		57.9		
HVPSA30HPA	208-230/1/60	18.7	2.8	16.7	20.8	25.0	33.3		41.7	50.0	62.5	35.4	39.5	43.7	52.0		60.4	68.7	81.2
HVPSA36HP1A	208-230/1/60	20.8	2.8	16.7	20.8	25.0	33.3		41.7	50.0	62.5	37.5	41.6	45.8	54.1		62.5	70.8	83.3
HVPSA42HP1A	208-230/1/60	23.5	2.8		20.8				41.7	50.0	62.5		44.3				65.2	73.5	86.0
HVPSA49HP1A	208-230/1/60	28.2	4.3		20.8				41.7	50.0	62.5		49.0				69.9	78.2	90.7
HVPSA60HPA	208-230/1/60	34.2	4.3		20.8				41.7	50.0	62.5		55.0				75.9	84.2	96.7
HVPSA24HPC	208-230/3/60	11.1	2.8			14.4		21.7		28.9	36.1				25.5	32.8		40.0	47.2
HVPSA30HPC	208-230/3/60	14.2	2.8			14.4		21.7		28.9	36.1				28.6	35.9		43.1	50.3
HVPSA36HP1C	208-230/3/60	17.2	2.8			14.4		21.7		28.9	36.1				31.6	38.9		46.1	53.3
HVPSA42HP1C	208-230/3/60	19.7	2.8			14.4		21.7		28.9	36.1				34.1	41.4		48.6	55.8
HVPSA49HP1C	208-230/3/60	21.1	4.3			14.4		21.7		28.9	36.1				35.5	42.8		50.0	57.2
HVPSA60HPC	208-230/3/60	23.6	4.3			14.4		21.7		28.9	36.1				38.0	45.3		52.5	59.7
HVPSA24HPD	460/3/60	5.8	1.4			7.2		10.8		14.4	18.0				13.0	16.6		20.2	23.8
HVPSA30HPD	460/3/60	7.1	1.4			7.2		10.8		14.4	18.0				14.3	17.9		21.5	25.1
HVPSA36HP1D	460/3/60	8.5	1.4			7.2		10.8		14.4	18.0				15.7	19.3		22.9	26.5
HVPSA42HP1D	460/3/60	9.0	1.4			7.2		10.8		14.4	18.0				16.2	19.8		23.4	27.0
HVPSA49HP1D	460/3/60	10.0	2.2			7.2		10.8		14.4	18.0				17.2	20.8		24.4	28.0
HVPSA60HPD	460/3/60	10.8	2.2			7.2		10.8		14.4	18.0				18.0	21.6		25.2	28.8

¹HP = Heat Pump Unit Amps (includes Indoor Motor amps) ²IBM = Indoor Blower Motor
Heating kW is rated at 240 volts on the 208-230v. (HPA & HPC) models. Derate heater output by 25% for operation at 208 volts. Heating kW is rated at 480 volts on the HPD models.
Total heating amps for single phase units with two circuits (#1 and #2) includes both circuits. Total heating and cooling amps includes all motors. Three phase models contain single phase motor loads.
Values shown are maximum phase loads. Loads are not equally balanced on each phase.

Unit Load Amps (Heating) - HVPSA Heat Pumps with 2-Stage Compressor and GreenWheel® Energy Recovery Ventilator - Ventilation Configuration ("H")

MODEL NUMBER	VOLTAGE PHASE HERTZ	CURRENT (AMPS)			LOAD OF RESISTIVE HEATING - ELEMENTS ONLY (AMPS) (1) ALL HEATING ELEMENTS ARE ON A SEPARATE CIRCUIT (2) SHADED VALUES (12 & 15 kW) UTILIZE TWO CIRCUITS								TOTAL MAXIMUM HEATING AMPS INCLUDES AMPS FROM MOTOR(S) THAT ARE LOCATED ON AN ELECTRICAL CIRCUIT THAT DOES NOT HAVE HEATERS							
		HP ¹	IBM ²	H ³	04 kW	05 kW	06 kW	08 kW	09 kW	10 kW	12 kW	15 kW	04 Kw	05 Kw	06 Kw	08 Kw	09 Kw	10 Kw	12 Kw	15 Kw
HVPSA24HPA	208-230/1/60	18.4	2.8	2.2	16.7	20.8	25.0	33.3		41.7			19.5	39.2	43.4	51.7		60.1		
HVPSA30HPA	208-230/1/60	20.9	2.8	2.2	16.7	20.8	25.0	33.3		41.7	50.0	62.5	19.5	41.7	45.9	54.2		62.6	70.9	83.4
HVPSA36HP1A	208-230/1/60	23.0	2.8	2.2	16.7	20.8	25.0	33.3		41.7	50.0	62.5	19.5	43.8	48.0	56.3		64.7	73.0	85.5
HVPSA42HP1A	208-230/1/60	25.7	2.8	2.2		20.8				41.7	50.0	62.5		46.5				67.4	75.7	88.2
HVPSA49HP1A	208-230/1/60	30.4	4.3	2.2		20.8				41.7	50.0	62.5		51.2				72.1	80.4	92.9
HVPSA60HPA	208-230/1/60	36.4	4.3	2.2		20.8				41.7	50.0	62.5		57.2				78.1	86.4	98.9
HVPSA24HPC	208-230/3/60	13.3	2.8	2.2			14.4		21.7		28.9	36.1				27.7	35.0		42.2	49.4
HVPSA30HPC	208-230/3/60	16.4	2.8	2.2			14.4		21.7		28.9	36.1				30.8	38.1		45.3	52.5
HVPSA36HP1C	208-230/3/60	19.4	2.8	2.2			14.4		21.7		28.9	36.1				33.8	41.1		48.3	55.5
HVPSA42HP1C	208-230/3/60	21.9	2.8	2.2			14.4		21.7		28.9	36.1				36.3	43.6		50.8	58.0
HVPSA49HP1C	208-230/3/60	23.3	4.3	2.2			14.4		21.7		28.9	36.1				37.7	45.0		52.2	59.4
HVPSA60HPC	208-230/3/60	25.8	4.3	2.2			14.4		21.7		28.9	36.1				40.2	47.5		54.7	61.9
HVPSA24HPD	460/3/60	6.9	1.4	1.1			7.2		10.8		14.4	18.0				14.1	17.7		21.3	24.9
HVPSA30HPD	460/3/60	8.2	1.4	1.1			7.2		10.8		14.4	18.0				15.4	19.0		22.6	26.2
HVPSA36HP1D	460/3/60	9.6	1.4	1.1			7.2		10.8		14.4	18.0				16.8	20.4		24.0	27.6
HVPSA42HP1D	460/3/60	10.1	1.4	1.1			7.2		10.8		14.4	18.0				17.3	20.9		24.5	28.1
HVPSA49HP1D	460/3/60	11.1	2.2	1.1			7.2		10.8		14.4	18.0				18.3	21.9		25.5	29.1
HVPSA60HPD	460/3/60	11.9	2.2	1.1			7.2		10.8		14.4	18.0				19.1	22.7		26.3	29.9

¹HP = Heat Pump Unit Amps (includes Indoor Motor amps) ²IBM = Indoor Blower Motor ³H = GreenWheel ERV
Heating kW is rated at 240 volts on the 208-230v. (HPA & HPC) models. Derate heater output by 25% for operation at 208 volts. Heating kW is rated at 480 volts on the HPD models.
Total heating amps for single phase units with two circuits (#1 and #2) includes both circuits. Total heating and cooling amps includes all motors. Three phase models contain single phase motor loads.
Values shown are maximum phase loads. Loads are not equally balanced on each phase.

Unit Load Amps (Heating) - HVPSA Heat Pump with 2-stage Compressor and GreenCube® Energy Recovery Ventilator - Ventilation Configuration "Q"

MODEL NUMBER	VOLTAGE PHASE HERTZ	CURRENT (AMPS)			LOAD OF RESISTIVE HEATING - ELEMENTS ONLY (AMPS) (1) ALL HEATING ELEMENTS ARE ON A SEPARATE CIRCUIT (2) SHADED VALUES (12 & 15 kW) UTILIZE TWO CIRCUITS									TOTAL MAXIMUM HEATING AMPS INCLUDES AMPS FROM MOTOR(S) THAT ARE LOCATED ON AN ELECTRICAL CIRCUIT THAT DOES NOT HAVE HEATERS								
		HP ¹	IBM ²	Q ³	04 kW	05 kW	06 kW	08 kW	09 kW	10 kW	12 kW	15 kW	04 Kw	05 Kw	06 Kw	08 Kw	09 Kw	10 Kw	12 Kw	15 Kw		
HVPSA36HP1A	208-230/1/60	21.1	2.8	1.1	16.7	20.8	25.0	33.3		41.7	50.0	62.5	19.5	41.9	46.1	54.4		62.8	71.1	83.6		
HVPSA42HP1A	208-230/1/60	23.8	2.8	1.1		20.8				41.7	50.0	62.5		44.6				65.5	73.8	86.3		
HVPSA49HP1A	208-230/1/60	29.4	4.3	1.1		20.8				41.7	50.0	62.5		50.2				71.1	79.4	91.9		
HVPSA60HPA	208-230/1/60	35.4	4.3	1.1		20.8				41.7	50.0	62.5		56.2				77.1	85.4	97.9		
HVPSA36HP1C	208-230/3/60	17.5	2.8	1.1			14.4		21.7		28.9	36.1				31.9		39.2	46.4	53.6		
HVPSA42HP1C	208-230/3/60	20.0	2.8	1.1			14.4		21.7		28.9	36.1			34.4		41.7		48.9	56.1		
HVPSA49HP1C	208-230/3/60	22.3	4.3	1.1			14.4		21.7		28.9	36.1			36.7		44.0		51.2	58.4		
HVPSA60HPC	208-230/3/60	24.8	4.3	1.1			14.4		21.7		28.9	36.1			39.2		46.5		53.7	60.9		
HVPSA36HP1D	460/3/60	8.7	1.4	0.6			7.2		10.8		14.4	18.0			15.9		19.5		23.1	26.7		
HVPSA42HP1D	460/3/60	9.2	1.4	0.6			7.2		10.8		14.4	18.0			16.4		20.0		23.6	27.2		
HVPSA49HP1D	460/3/60	10.6	2.2	0.6			7.2		10.8		14.4	18.0			17.8		21.4		25.0	28.6		
HVPSA60HPD	460/3/60	11.4	2.2	0.6			7.2		10.8		14.4	18.0			18.6		22.2		25.8	29.4		

¹HP = Heat Pump Unit Amps (includes Indoor Motor amps) ²IBM = Indoor Blower Motor ³Q = GreenCube® ERV
 Heating kW is rated at 240 volts on the 208-230v. (HPA & HPC) models. Derate heater output by 25% for operation at 208 volts. Heating kW is rated at 480 volts on the HPD models.
 Total heating amps for single phase units with two circuits (#1 and #2) includes both circuits. Total heating and cooling amps includes all motors. Three phase models contain single phase motor loads.
 Values shown are maximum phase loads. Loads are not equally balanced on each phase.

HVPA & HVPSA Air Flow (CFM) at Various Static Pressures

MODEL	0.10	0.20	0.25	0.30	0.40	0.50
24	800	770	725	680	600	500
30	1200	1100	1050	1000	900	800
36	1290	1170	1115	1060	1000	920
42	1500	1360	1295	1230	1160	1070
49	1900	1800	1700	1600	1500	1350
60	2200	2100	2000	1900	1800	1650

Dimensional Data for AVPA24 (inches and mm)

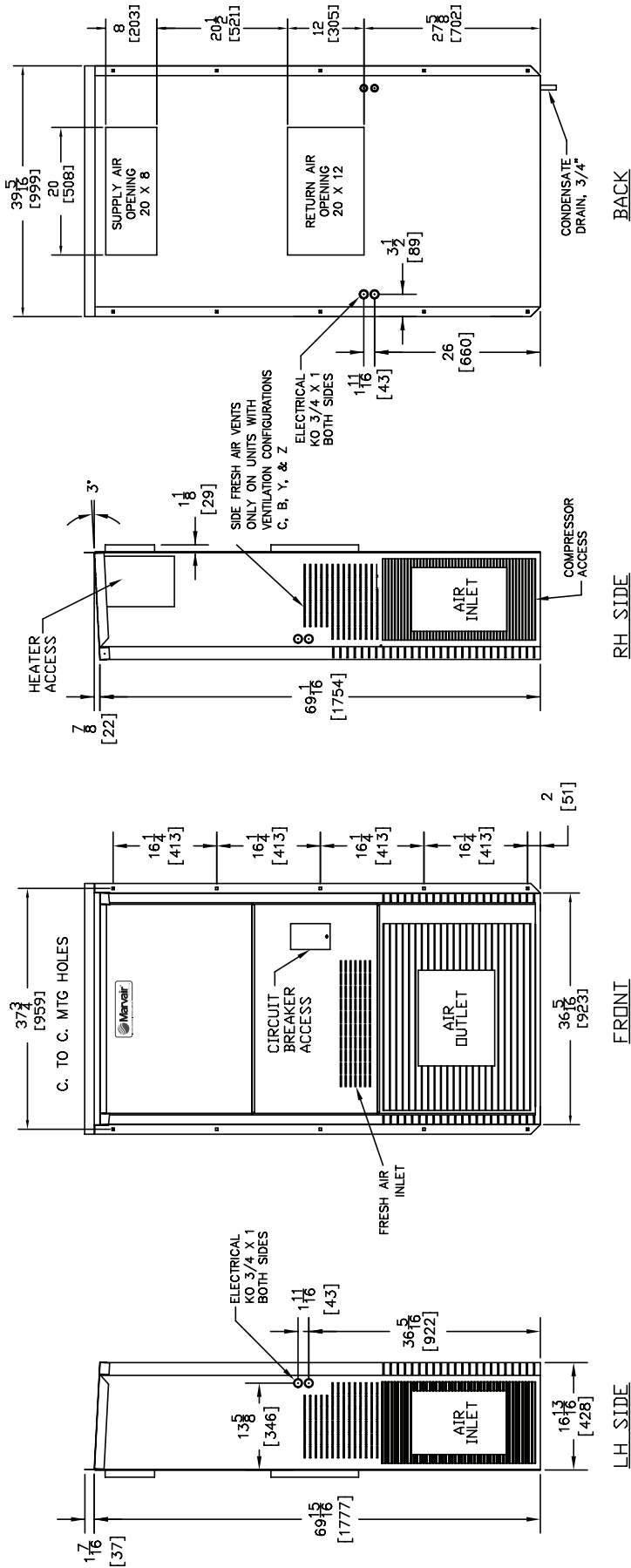

Shipping Weight (pounds/kilograms)

	LBS/KGS
AVPA24	275/125
WITH VENTILATION CONFIGURATION "N"	286/130
WITH VENTILATION CONFIGURATION "C", "B", "Y", & "Z"	

Filter Size

AVPA24	INCHES	MILLIMETERS	PART NUMBER	FILTERS PER UNIT	MERV RATING
RETURN AIR FILTER	25 x 16 x 1	635 x 406 x 25	80135	1	7

BOTTOM MOUNTING BRACKET

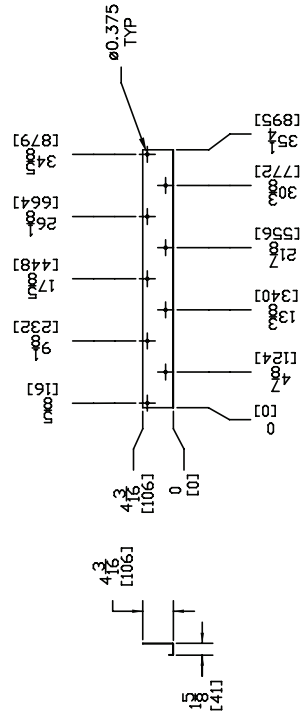

Dimensional Data for AVPA42/48/60, HVPA30/36/42 and HVPSA36/42 (inches and mm)

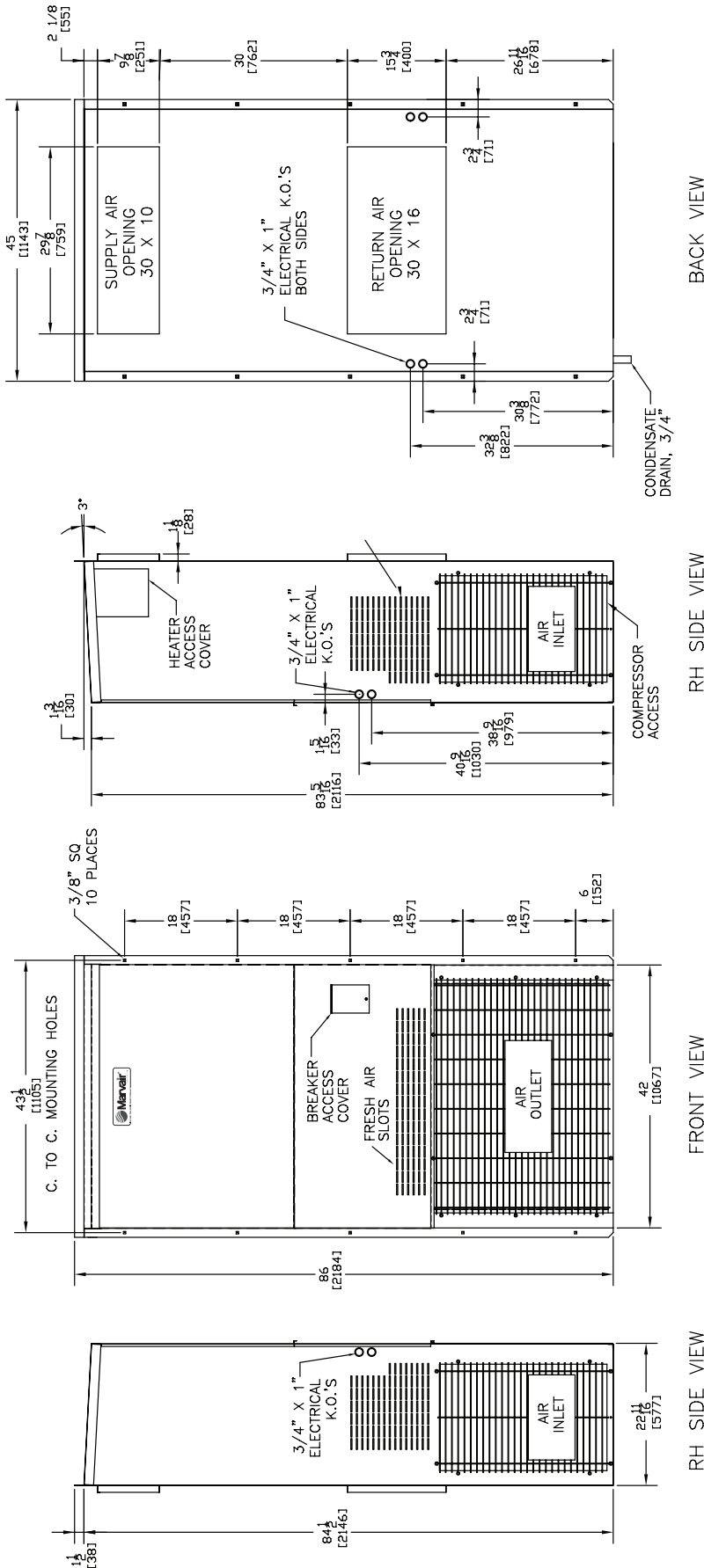

Shipping Weight (pounds/kilograms)

AVPA42/48/60, HVPA30/36/42, & HVPSA36/42	LBS/KGS
WITH VENTILATION CONFIGURATION "N"	535/245
WITH VENTILATION CONFIGURATION "C", "B", "Y", & "Z"	590/268

Filter Size

AVPA42/48/60, HVPA30/36/42, & HVPSA36/42	INCHES	MILLIMETERS	PART NUMBER	FILTERS PER UNIT	MERV RATING
RETURN AIR FILTER	36 1/2 x 22 x 1	927 x 559 x 25	80139	1	7

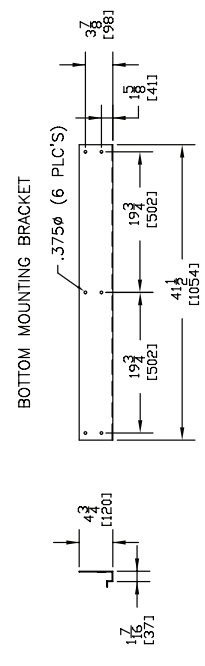

The GreenCube® ERV is only available on HVPSA units (2-stage compressor). All HVPSA units with the GreenCube® ERV, including the HVPSA36 and HVPSA42 are in the HVPSA49/60 cabinet.

Dimensional Data for HVPA49/60 and HVPSA49/60 (inches and mm)

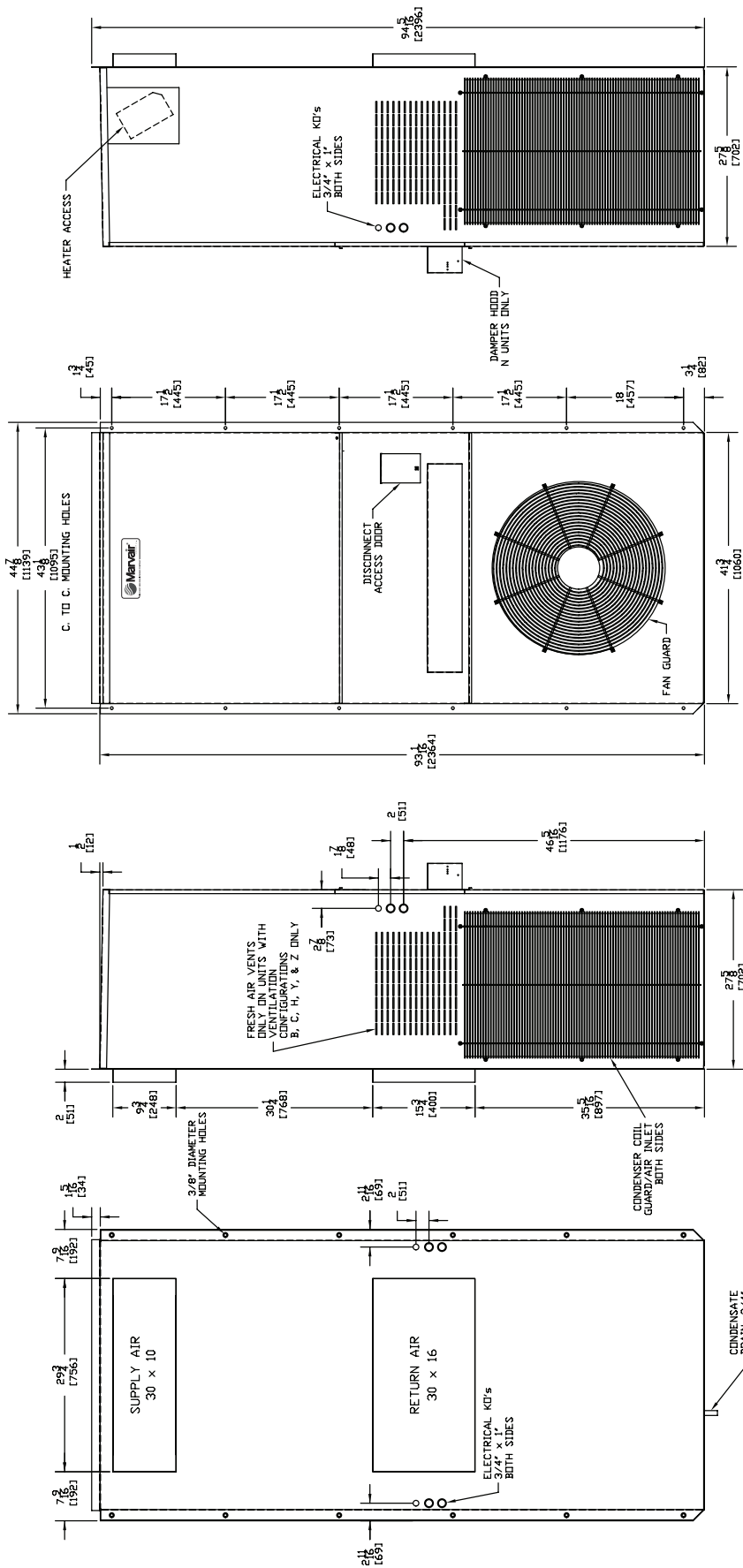

Shipping Weight (pounds/kilograms)

HVPA49/60 & HVPSA49/60	LBS/KGS
WITH VENTILATION CONFIGURATION "N"	625/284
WITH VENTILATION CONFIGURATION "C", "B", "Y", & "Z"	640/291
WITH EITHER GREENWHEEL ERV OR GREENCUBE® ERV	810/369

Filter Size

HVPA49/60 & HVPSA49/60	INCHES	MILLIMETERS	PART NUMBER	FILTERS PER UNIT	MERV RATING
RETURN AIR FILTER	18 x 24 x 1	457 x 610 x 25	81199	2	7
INTAKE AIR FILTER*	14 x 14 x 1	356 x 356 x 25	80192	1	N/A
RETURN AIR FILTER (STD)**	16 x 24 x 1	406 x 635 x 25	92367	2	7
RETURN AIR FILTER (OPT)**	16 x 24 x 2	406 x 635 x 51	91968	2	8
INTAKE AIR FILTER**	9 3/4 x 22 3/4 x 3/4	248 x 222 x 19	92113	1	N/A
EXHAUST AIR FILTER**	9 3/4 x 22 3/4 x 3/4	248 x 222 x 19	92113	1	N/A

*Units with the GreenWheel ERV **Units with the GreenCube® ERV

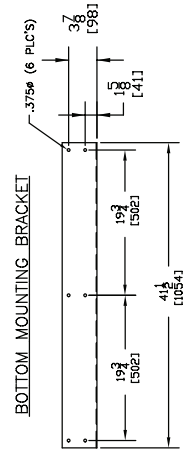

NOTE: HEAT PUMPS WITH THE GREENCUBE® ERV (Q VENTILATION CONFIGURATION) HAVE IDENTICAL MOUNTING HOLES, THE SAME SUPPLY & RETURN AIR OPENINGS AND THE SAME OVERALL DIMENSIONS. THE CONTROL BOX ON UNITS WITH THE GREENCUBE® ERV IS ON THE RIGHT SIDE OF THE UNIT.

Dimensional Data for AVPA42/48/60, HVPA30/36/42, & HVPSA36/42 with the GreenWheel ERV (inches and mm)

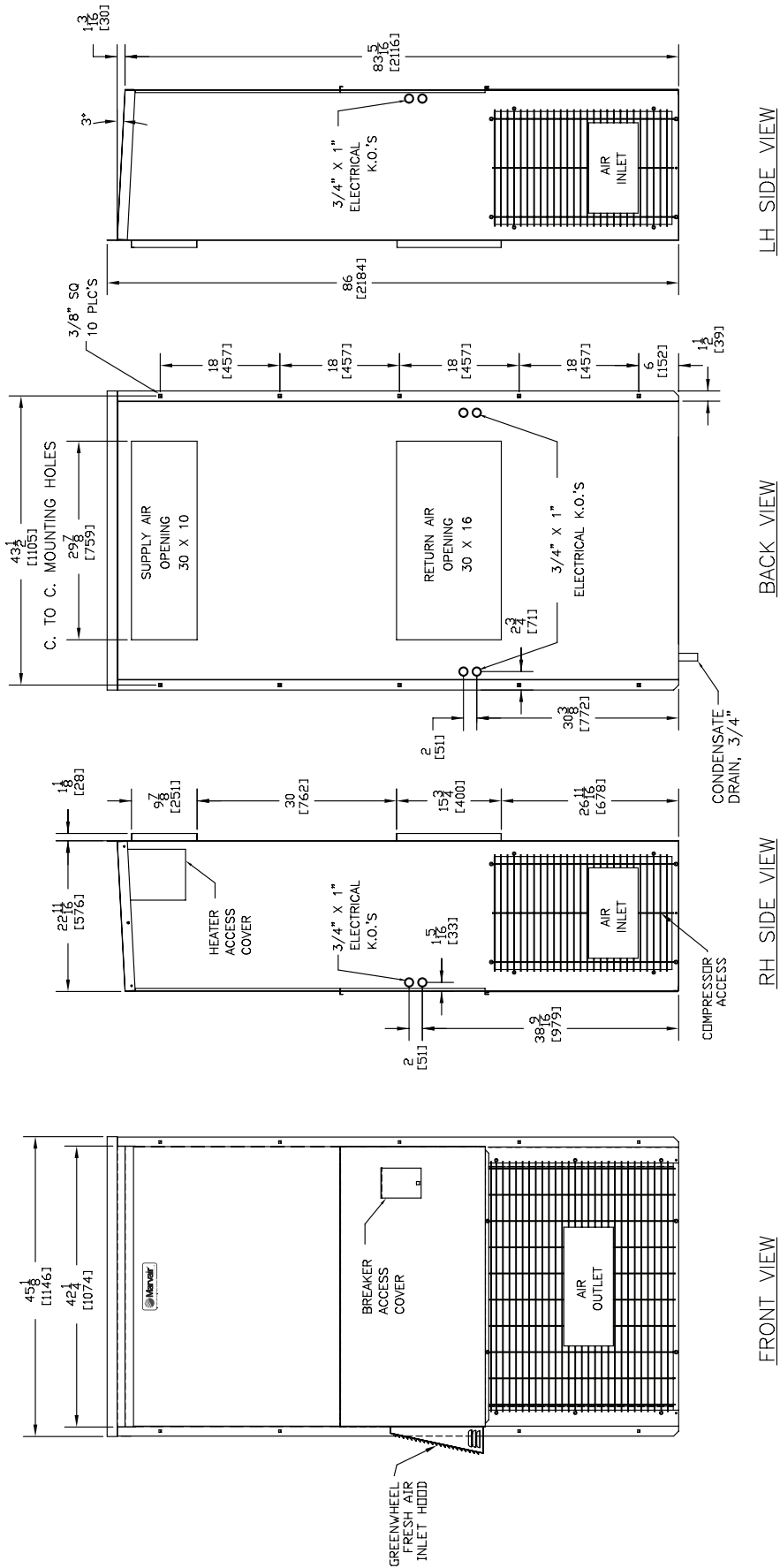

Shipping Weight (pounds/kilograms)

AVPA42/48/60, HVPA30/36/42, & HVPSA36/42	LBS/KGS
With GreenWheel ERV	590/268

Filter Size

AVPA42/48/60, HVPA30/36/42, & HVPSA36/42 with GreenWheel ERV	INCHES	MILLIMETERS	PART NUMBER	FILTERS PER UNIT	MERV RATING
RETURN AIR FILTER	36 x 22 x 1	927 x 559 x 25	80139	1	7
INTAKE AIR FILTER*	14 x 14 x 1	356 x 356 x 25	80192	1	N/A

*Units with the GreenWheel ERV

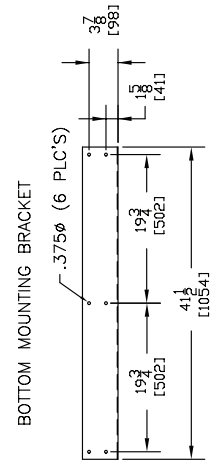

Notes



Notes